

Instruction manual

for

Multi-System 5000

L3160-00-53.00E
Version 2.9

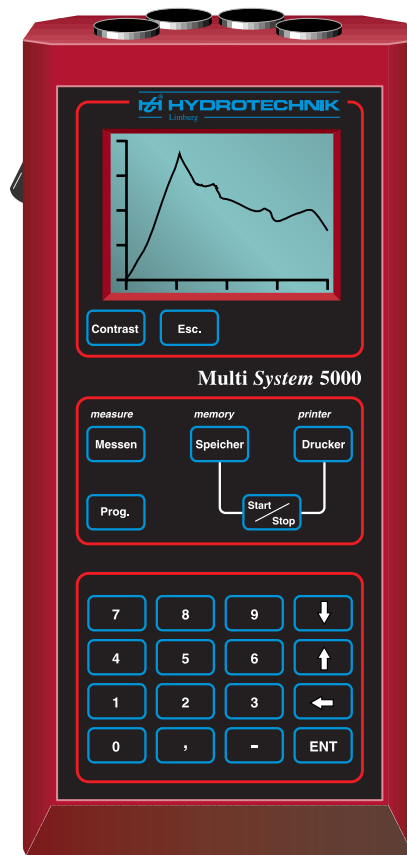

Please read your instruction manual carefully, before putting your measuring instrument in operation.

Preface

This user manual is a description of the hand held measuring instrument Multi-System 5000 with discretionary measuring inputs:

- four analogue measuring inputs for standardised input signals from 0 to 20 mA or 4 to 20 mA
- two frequency inputs for pulses from 2 mV to 10 V

Even though difficulties in operating the Multi-System 5000 are unlikely to occur, you will only be able to exploit all its efficiency when you know the instrument in full detail. Should you encounter unexpected problems, please ask for our support.

Alterations are subject to technical progress.

We hope that you will experience your Multi-System 5000 as a reliable partner for exact and easy measurements.

Index

General notes	5
Connection possibilities for Multi-System 5000	6
Description of the function keys	7
Instructions for charging batteries	9
Connection of sensors	10
1. Putting into operation of measuring instrument	11
Programming structure when selecting „measuring“	13
2. Menu "measure"	14
2.1 Definition of measuring channels	14
2.2 Definition of a single measuring channel for a measurable variable	14
2.3 Blocked function	14
2.4 Calculation of two channels	15
2.5 Linkage of two measuring channels	15
2.6 Calculation of the difference from two measuring channels	15
2.7 Selection of measurable variable for display	16
2.8 Maximum selection of measurable variable for display	16
2.9 Magnification of display (max. 4 measurable variables)	16
2.10 Definition of display for measuring values or min.-max. values	17
2.11 Measuring value display	17
2.12 Display of min./max.-values	17
Programme structure when selecting "Programming"	18
3. Menu "Programming"	19
3.1 Programming of analogue measuring channels 1-4	19
3.2 Adjustment of output signal of sensor to 0 to 20 or 4 to 20 mA	19
3.3 Input of calibration value	20
3.4 Zero point alignment for an analogue channel	20
3.5 Linearisation ..	21
3.6 Input of a table	21
3.7 Assigning identification numbers for table	21
3.8 Input of linearisation values	21
3.9 Selection of a linearisation table	22
3.10 Deletion of linearisation table	22
4. Programming of a measuring channel for temperature measurement	23
4.1 Adjustment of the temperature measuring range.....	23
5. Programming of measuring channels for measuring volume flow rate	24
5.1 Selection of measuring principle.....	24
5.2 Volume flow rate measurement with higher accuracy through input of linearisation values	24
5.3 Input of a table	25
5.4 Assigning an identification number for the table	25
5.5 Input of linearisation values	25
5.6 Selection of linearisation table	26
5.7 Deletion of linearisation tables	26
6. Volume flow rate measurement with orifice gauge	27
6.1 Selection of orifice gauge type	27
6.2 Alignment of orifice gauge	27
6.3 Connection scheme of an orifice gauge	27
7. Measurement of RPM	28
7.1 Input of pulses per revolution	28
8. Precise pressure differential measurement by programming additional calculation of two measuring channels	29
8.1 Connection scheme of a pressure differential measurement	29
8.2 Definition of calculation variables for a pressure differential measurement	29
8.3 Alignment of both pressure sensors at identical working pressure	30

9.	System adjustments	31
9.1	Adjustment of language	31
9.2	Adjustment of date and time	31
9.3	Adjustment of Baud rate for interface RS 232	31
10.	Menu "Memory"	32
10.1	Carrying out an optimal storage	32
10.2	Memory channels	32
10.3	Scanning rate.....	32
10.4	Invocation of memory	33
10.5	Calling parameters	33
10.6	Selecting measurable variables for storage	33
10.7	Defining of scanning rate	33
10.8	Defining of storing time	34
11.	Selection, adjustment and application of the trigger	34
11.1	Trigger type „NONE“	34
11.2	Trigger type „KEY“	35
11.3	Trigger type „VALUE“	35
11.4	Trigger type „EDGE“	36
11.5	Display and function of the pretrigger for internal and manual triggering	37
11.6	Trigger adjustment „VALUE“	39
11.7	Start memory	40
11.8	Fix memory name	40
11.9	Active memory display	40
11.10	Display memory	41
11.11	Select stored data file	41
11.12	Determining of the min./max. values of a data file	41
11.13	Display of the min./max. values of a data file	42
11.14	Manual Scaling	42
11.15	Display of graphics	43
11.16	Selection of measurable variables for graphic display	43
11.17	Display a course of a curve	43
11.18	Deleting measuring value memory	43
11.19	Deleting the min./max. memory	44
12.	Menu "Printer"	44
12.1	Printer selection	44
12.2	Print out of tables	45
12.3	Selecting data files	45
12.4	Fixing the range of a data file	45
12.5	Selecting measurable variables to be printed	45
12.6	Display while printing tables	45
12.7	Printing graphics	46
12.8	Selecting data files	46
12.9	Fixing the range of a data file	46
12.10	Fixing the scaling	46
12.11	Fixing graphic markings	46
12.12	Selecting measurable variables to be printed	47
12.13	Display while printing graphics	47
13.	Re-initialization of the Multi-System 5000	47
13.1	Selection initialisation	47
13.2	Programming data of Multi-System 5000	48
14.	Pin connection of the measuring instrument Multi-System 5000	49
15.	Technical information for the connection pressure sensors 0 to 20 mA and 4 to 20 mA	50
16.	Processing times (internal calculation time) of the Multi-System 5000	51
17.	Pin connection of the HYDROTECHNIK-sensors	52
18.	Measuring cable with pin connections	55
19.	Error detection	56
20.	Technical data for the Multi-System 5000	57
21.	Information on guarantee	58
22.	Maintenance	58
	Appendix: Repair form (to be sent in with Multi-System 5000 in case of repair)	

General notes

The Multi-System 5000 made by HYDROTECHNIK GmbH Limburg, Germany, is an efficient battery-powered hand-held measuring instrument for various physical variables. You can choose from two digital and 4 analogue inputs. The digital inputs can be connected with sensors with output signals between 2 mV and 10 mV and sensors with standardised output signals from 0 to 20 mA and 4 to 20 mA can be connected to the analogue inputs.

Thus others than HYDROTECHNIK sensors may be used, provided that their output signals do not exceed the above-mentioned values and that a voltage of 10 to 30 VDC is supplied.

Today, modern measuring instruments do not only have to acquire and display measuring values, but, to an increasing extent, should store these values, too.

Therefore, the Multi-System 5000 disposes of two independent memories, one of them being a min/max. memory, permanently calculating and storing the min/max. values of the six measuring channels. The other memory with its capacity of 250 kB (250,000 measuring values) allows the storage of a maximum of 20 data files. For the storage of measuring data there are different trigger adjustments, which can be adapted to the various measuring tasks.

A special option enables the user to display and store quantities, calculated by the linkage of two measuring channels (subtraction or addition). The stored data files are automatically provided with date and time and can be printed as tables or graphics, even at a later time. This is possible either for the complete data file or for a special part.

The software of the Multi-System 5000 was developed and tested most carefully, but even that cannot totally rule out software errors. Should you detect a software error, please inform HYDROTECHNIK accordingly within the guarantee period. We will send you an update, free of charge.

For the first time you have the possibility to invoke and display the stored data file directly as a graphic course. In doing so, you can directly see the characteristic course of your measuring curve, correct it according to your measuring tasks and modify the measuring parameters in a way, that you will receive the required measuring result.

The min/max. values of a stored data file can be displayed at the same time.

Via the RS 232 interface, data can directly be transferred to a PC or Laptop with a rate of 38400 Baud.

The PC-software „HYDROcomsys“, developed by HYDROTECHNIK, is designed to process large data volumes with both, tables and graphics, and to analyse measuring values with statistical evaluation.

For that, a text editor to enter useful comments and the possibility to select several windows is advantageous.

Technical structure

All electronic parts are in a plastic housing with a special battery compartment on the back, the lid of which can be unscrewed, so that the user can easily carry out a change of the high-performance nickel-cadmium battery (14,4V/1Ah).

For recharging the batteries and for long-term stationary operation HYDROTECHNIK offers a separate plug-in power unit 230 VAC / 24 VDC.

A characteristic feature of the Multi-System 5000 is its surface with only 4 keys that control all subroutines.



The start/stop key serves for a manual start or stop in the memory and printer programme, only.

All other keys serve for the input of measuring ranges, calibration values, linearisation tables, scaling, etc.

In the eight-line graphic-display six external measuring values and two internally calculated measurable variables can be displayed at the same time, as a maximum of six sensors can be connected simultaneously. As there are only four measuring inputs at the front of the Multi-System 5000, a divider cable is needed for the simultaneous connection of two pressure sensors to one analogue input (to K1 and K2, or to K3 and K4).

When using a dual sensor for pressure and temperature, this cable is not necessary.

The internal software of the Multi-System 5000 can mathematically evaluate a pressure- or temperature differential and display it, however two corresponding are always needed for this.

Connection possibilities for Multi-System 5000

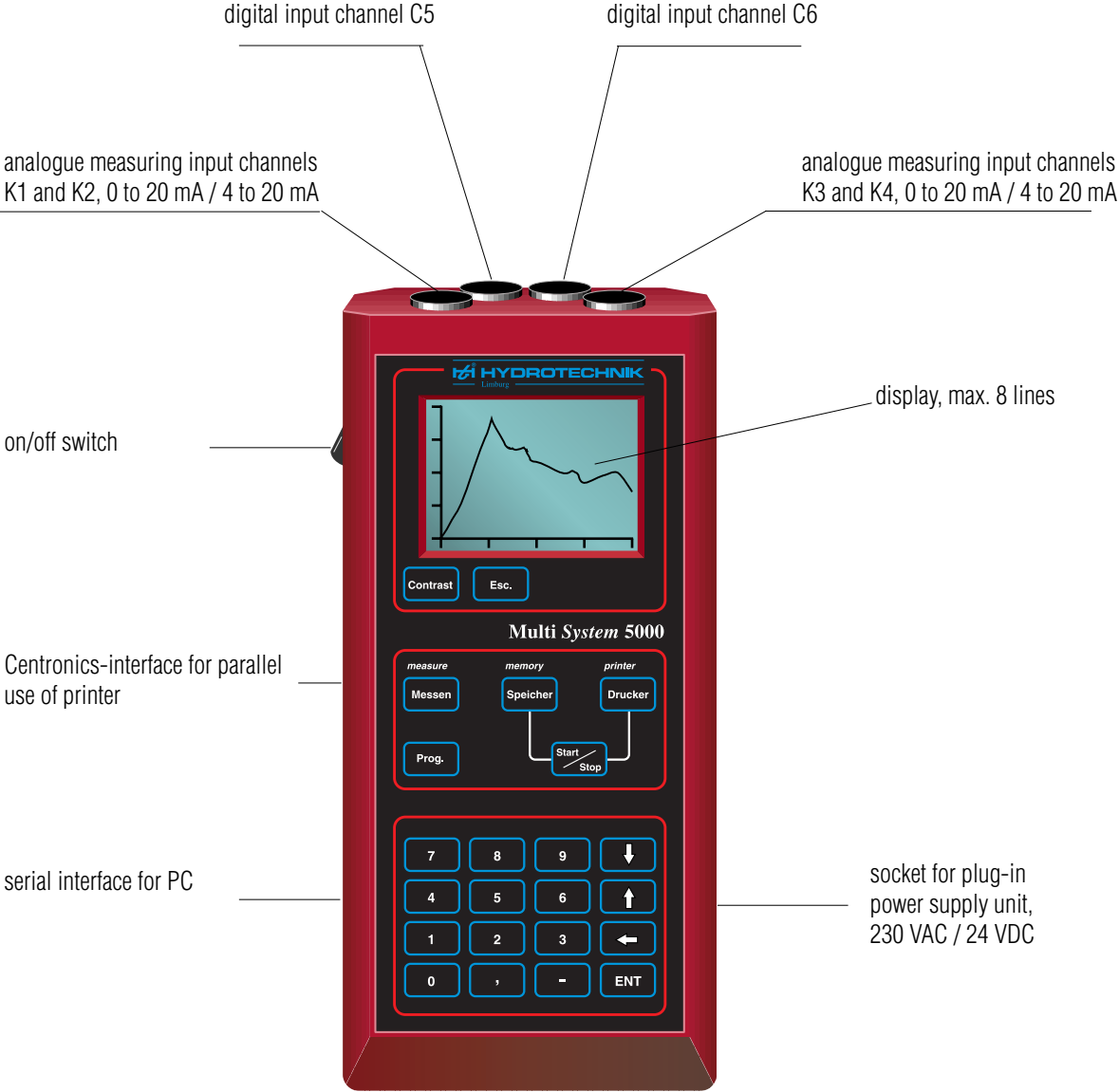

Description of the function keys



Contrast

By continuously pressing key „Contrast“, the brightness of the display can be adjusted individually. As soon as the key is released the respective brightness will be stored and will remain unchanged even when the instrument is switched off.



Esc.

Programme interrupt

By pressing the „Esc.“ key any subroutine can be left and the previous function will be displayed. In certain subroutines, where an input is required, a program interrupt is only possible after the confirmation with key „ENT“ and a stroke of key „Esc.“ afterwards.

measure



Measure

Selection of programme „Measure“

There are four subroutines available:

- definition of measuring channels
- definition of calculation
- selection of display
- definition of display



Programming

Input of data for the measuring sensors:

analogue sensor type 0 to 20 mA or 4 to 20 mA,
calibration value, zero point correction or linearisation values
measurement of frequency by turbine or gearwheel

memory



Memory

Selection of programme „Memory“

There are six subroutines available:

- display of all parameters
- input of individual parameters
- start of a storage
- display of memory
- deletion of memory
- deletion of the min./max. values

These subroutines are necessary to fulfil all requirements of the measuring values and parameters to be stored.

printer



Printer

Selection of „Printer“

There are three subroutines available:

- selection of printer
- printout as table
- printout as graphic



Start/Stop-function

With this key, the programme can be started or stopped in memory- and print mode.

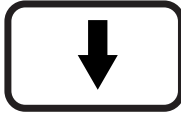

Movement within the display

The two cursor keys serve for the selection of preset values in the display according to their direction, or for the switching to another display.

The selection needs to be confirmed with key „ENT“, for example the changing of the storage time from seconds in minutes.



Selection of sign

This key serves for the input of the sign into the X/Y-axis for the printer scaling, e.g. -50 °C.



Correction input

With the cursor key, wrong inputs can be corrected. The cursor is set to the left side and the wrong input can be overwritten.

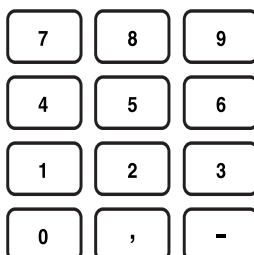

Block of numbers with decimal point

Input of the requested numbers with or without decimal point, e.g. calibration value, measuring range end value, etc.



Confirmation

After having entered a value, you have to confirm this input with key ENT.

Instructions for charging the batteries

Before each operation of the measuring instrument, you should make sure that the nickel-cadmium batteries are fully charged. The use of a HYDROTECHNIK plug-in power supply unit (primary 230 VAC, secondary 24 VDC) ensures a continuous charging of the batteries.

Please take into consideration that the batteries are only slightly charged when leaving the manufacturer. We recommend connecting the plug-in power supply unit to the measuring instrument for at least approx. 14 to 16 hours prior to initial use.

The measuring instrument is able to measure when supplied by any other power unit or a car battery but in such cases the recharging of the batteries can not be ensured, as a stabilised power source of 24 to 30 VDC is needed for this.

If a battery is discharged it should be recharged for 16 hours, the instrument being switched off.

The service life of nickel-cadmium batteries can be very long, depending greatly on their respective working conditions. It should be avoided that the batteries are totally discharged, permanently recharged or immediately recharged after each use. Discharging them below 50 % and recharging them afterwards has got a positive impact on the life span of nickel-cadmium batteries. Due to the so-called memory-effect that reduces cell capacity, recharging nickel-cadmium batteries after very short time of use cannot be recommended. If the battery is repeatedly discharged to a minor degree but immediately recharged, the cell's capacity will soon be reduced. If that is done over a longer period of time the battery can suffer permanent damage. There is a chance, however, to regenerate said damage by a number of discharging and recharging cycles, i.e. by using the instrument for a longer period and then recharging the battery.

Should the batteries not be charged sufficiently, a warning will be displayed „Charge batteries“. In such cases a minimum of 16 hours recharging time is urgently required.

Connection of sensors

In the following diagram, several possibilities for the connection of sensors, including measuring cables and the corresponding inputs, are shown:

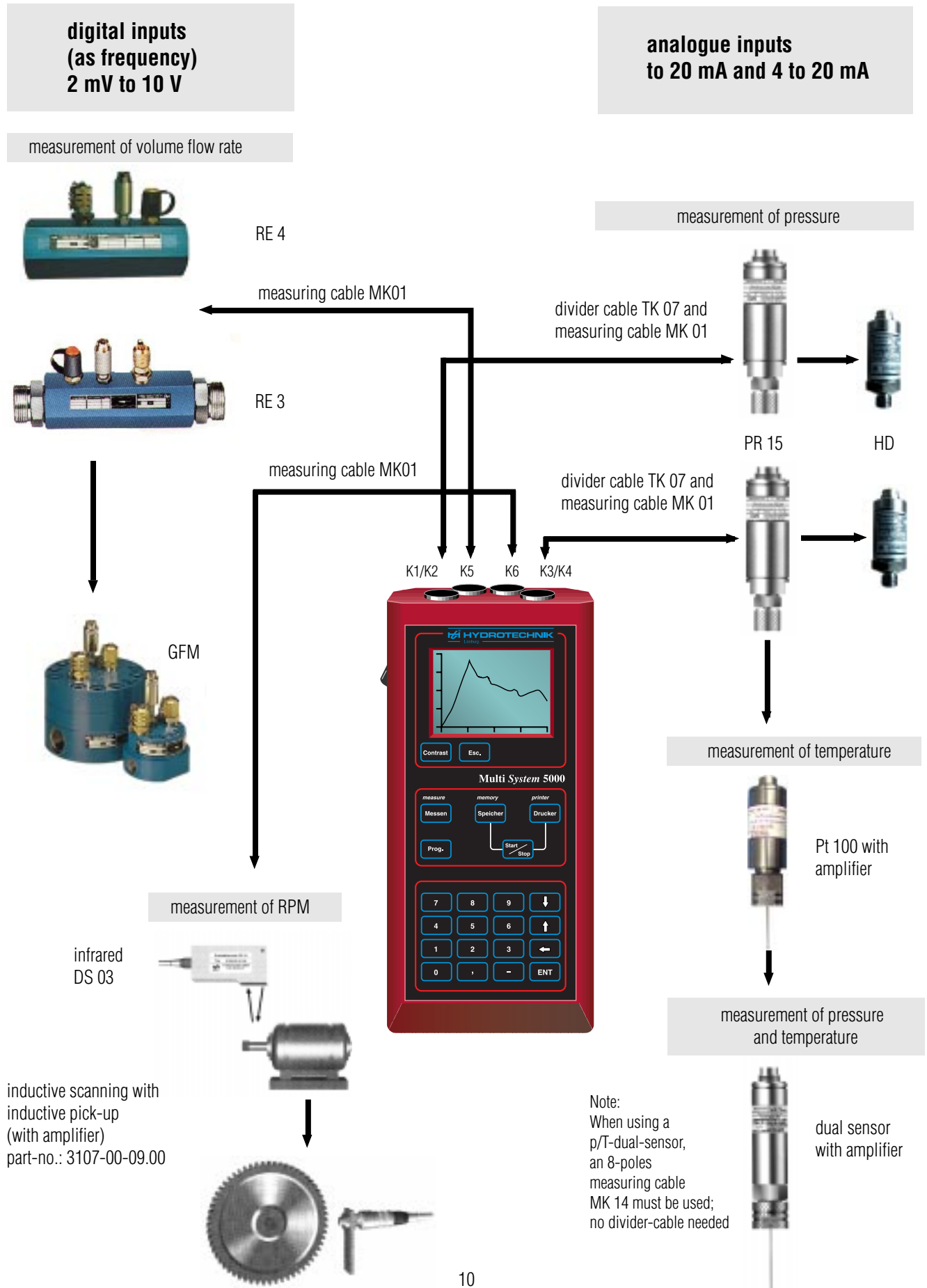

1. Putting into operation of the measuring instrument

Before describing the measuring instrument in more detail, we want to assure you that it was our aim to write a practice oriented user manual, which will enable you to understand the logical connections within the structure of the programme, through its clear structure and easily remembered graphics. By this, you will soon need it only in very specific cases.

If you have to carry out measurements that aren't applied frequently, a short look at the index should be enough to bring all steps of the operation back to your memory.

When the instrument is switched on, a display will be shown for about 4 seconds that indicates the initialisation and the current programme version.

For technical inquiries it is imperative to state the respective version in use.

Programme version

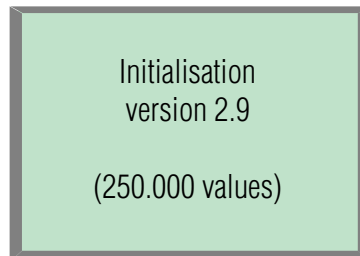

Initialisation
version 2.9

(250.000 values)

After the current programme version was shown, the measuring value display will automatically appear (the example shows an arbitrarily chosen 8-line measuring value display).

Measuring value display

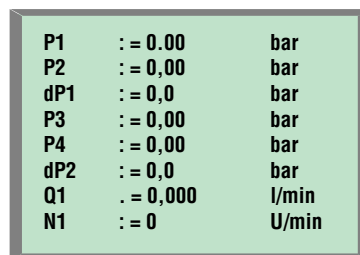

P1	: = 0.00	bar
P2	: = 0,00	bar
dP1	: = 0,0	bar
P3	: = 0,00	bar
P4	: = 0,00	bar
dP2	: = 0,0	bar
Q1	. = 0,000	l/min
N1	: = 0	U/min

With the following four keys, the subroutines are invoked, in order to carry out the required commands and programme steps:

measure programming memory printer

measure

Messen

Prog.

memory

Speicher

printer

Drucker

The Multi-System 5000 provides menus for the different programme steps, so that you can choose, in some cases enter some data and confirm. Once all steps are chosen and programmed it is very easy to carry out measurements with the instrument.

The following diagram shows the structure of the four main programmes:

Measuring value display:

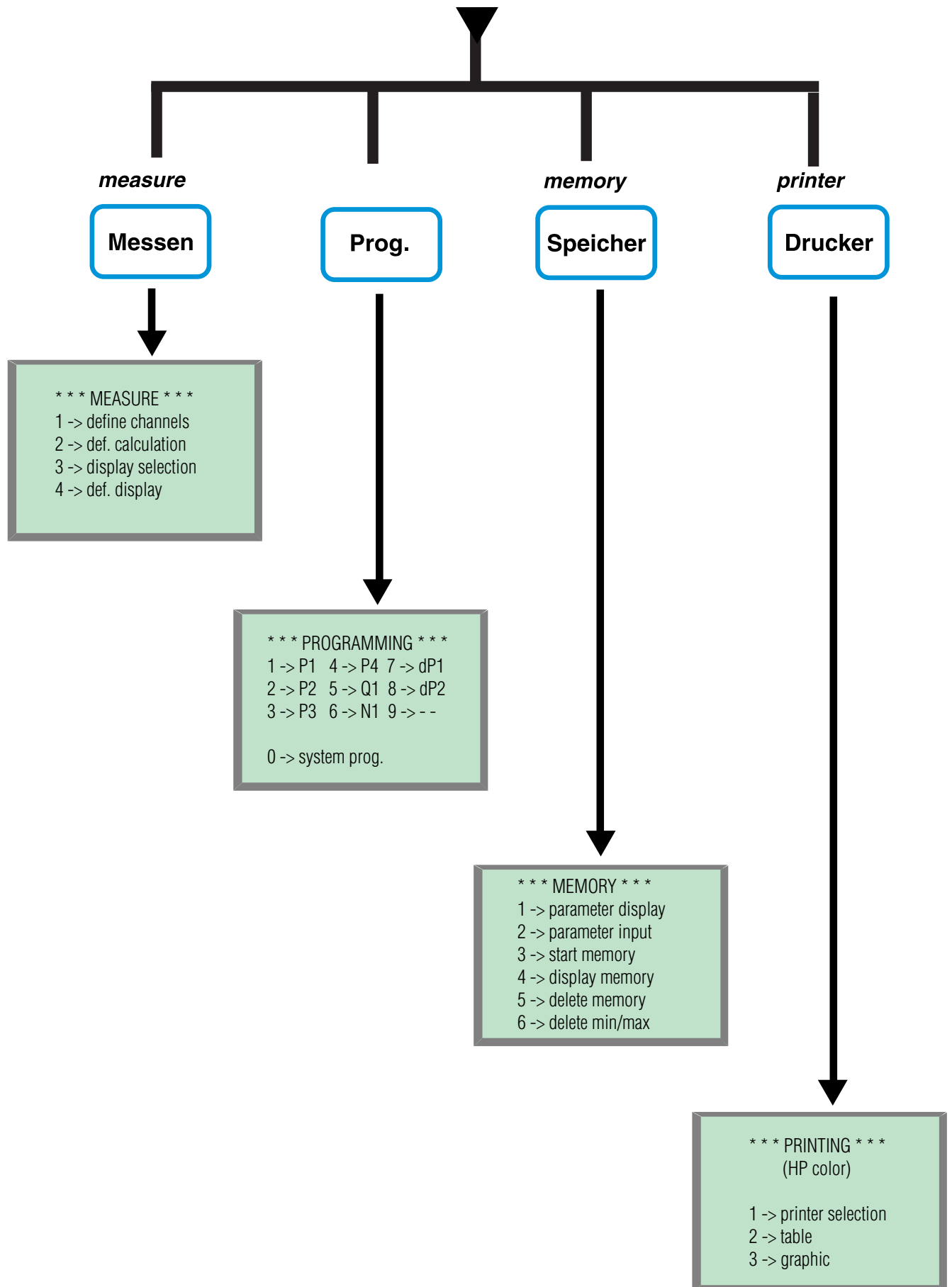

Programme structure when selecting „measure“

P1	:= 0.00	bar
P2	:= 0.00	bar
dP1	:= 0.0	bar
P3	:= 0.00	bar
P4	:= 0.00	bar
dP2	:= 0.0	bar
Q1	:= 0.000	l/min
N1	:= 0	U/min

Measuring value display:
 pressure P1-P4
 pressure differential (P1-P2) and (P3-P4)
 volume flow rate Q1 and rev. speed N1

measure
 Messen

*** MEASURE ***
 1 -> define channels
 2 -> def. calculation
 3 -> display selection
 4 -> def. display

subroutine „measure“

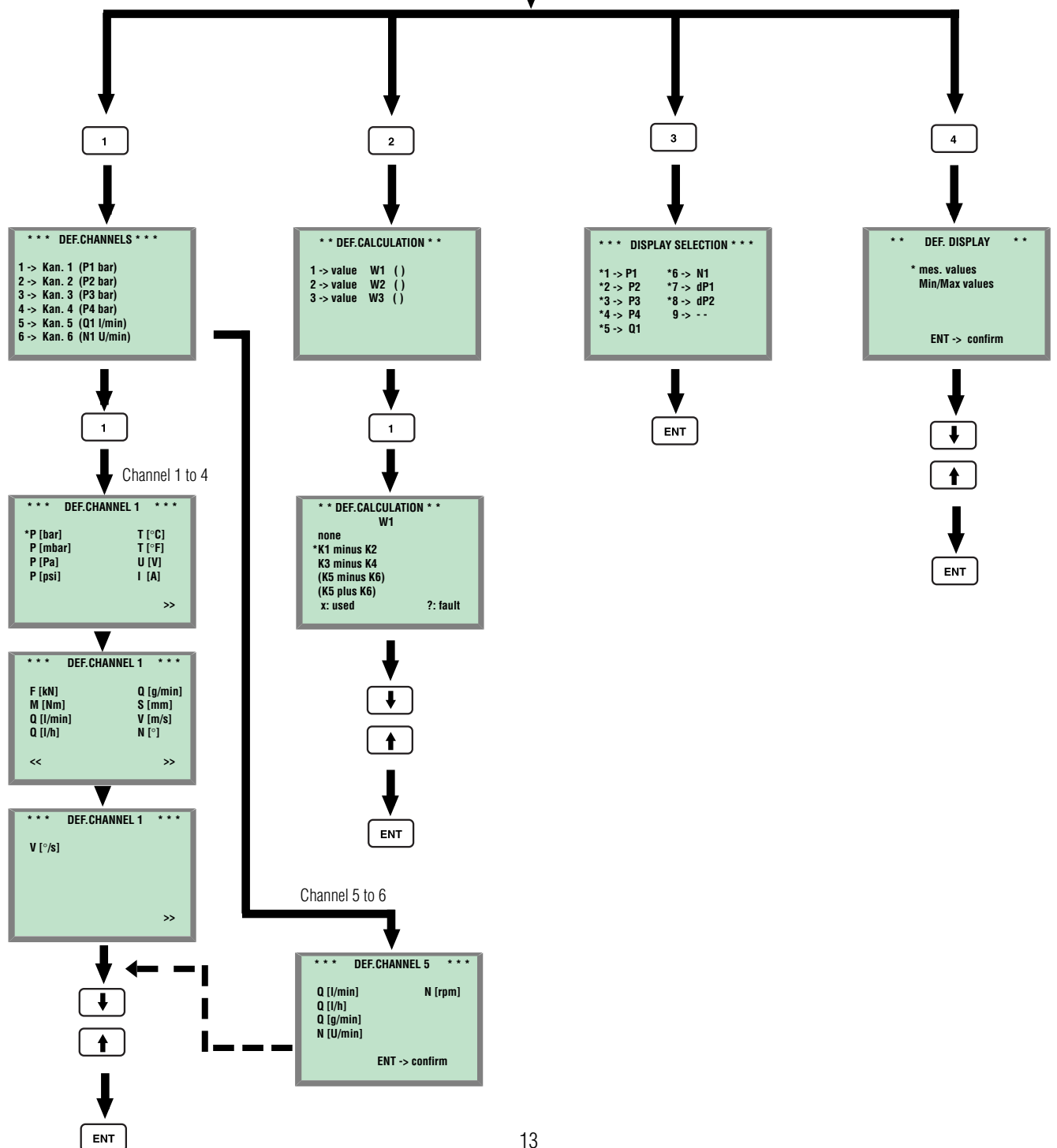

2. Menu „measure“

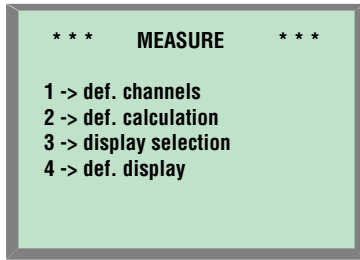

2.1 Definition of measuring channels

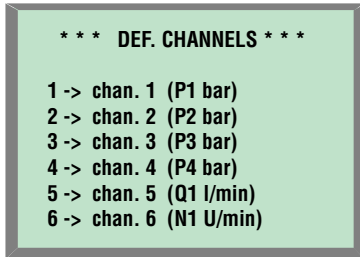

2.2 Definition of a single channel for one measurable variable

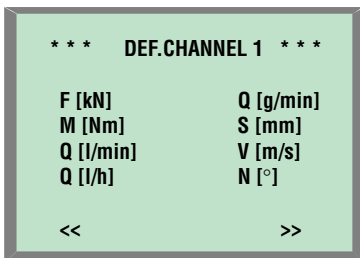
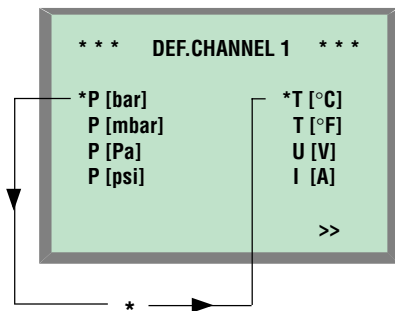

2.3 Blocked function

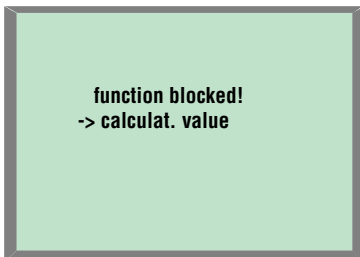



With key , the submenu is invoked and four different programme steps can be chosen.

1 -> definition measuring channels means: definition of measurable variables for the six measuring inputs, e.g. pressure in bar, temperature in °C, etc.



2 -> definition calculation means: definition of a maximum of 3 calculating variables, calculation of a pressure differential or of a sum

3 -> selection display means: definition of measuring values to be displayed (max. 8)

4 -> definition display means: definition, if only measuring values or their min./max.-values shall be displayed

To start with „1-> Def. measuring channels“, press key . The display, shown on the left, will appear for selection of the six measurable variables. Another stroke of key  leads to the display „Def. channel 1“.

Now, channel 1 can be defined, for example to measure tempera-

tures. With one of the two cursor keys  or  the star symbol is shifted from *P(bar) to *T (°C).

The sign „>>“ means that there is one more page available, in which further measurable variables are displayed.

The cursor-keys ensure comfortable selection, for which you only have to pay attention to the direction of the arrows.

Once the desired measurable variable is chosen, the selection is stored by pressing key .

All other channels are defined the same way.



When the notice “function blocked “ appears on the display, the channel can be re-defined only, if the calculation for the respective channel was deleted, before. On the following page, this procedure will be described in more detail.

Please bear in mind that the measuring channels 1 to 4 are designed for sensors with signals of to 20 mA and 4 to 20 mA.

Channels 5 and 6 are designed for sensors, that provide a frequency signal.

When a channel is re-defined, e.g. from P1(bar) to T(°C), usually all stored parameters are deleted. Only in cases of changing from bar to psi or from l/min to gal/min those parameters are maintained.

2.4 Calculation of two channels

```

*** MEASURE ***
1 -> def. channels
2 -> def. calculation
3 -> display selection
4 -> def. display
    
```

Starting from menu „measure“, the next menu „2-> Def. calculation“ is invoked with key .

2.5 Linkage of two measuring channels

```

*** DEF. CALCULATION ***
1 -> value W1      ()
2 -> value W2      ()
3 -> value W3      ()
    
```

Several calculations may be defined in the Multi-System 5000. A calculation always needs the linkage of two measuring channels or the comparison of two identical physical variables.

As an example the values of channel 1 (P1) and channel 2 (P2) shall be subtracted. For this, the next menu step needs to be invoked with key .

The display, shown on the left side, will appear.

Press key to shift the star symbol to „K1 minus K2“ and

confirm your selection with key .

2.6 Calculation of the difference from two measuring channels

```

*** DEF. CALCULATION ***
          W1
* none
* K1 - K2
* K3 - K4
* K5 - K6
* K5 + K6
x: used           ?: fault
    
```

In the first line of the display „1-> value W1 (dP1)“ is shown, what means, that the pressure differential dP1 is calculated from channel 1 and channel 2 (= P1 - P2).

```

*** DEF. CALCULATION ***
1 -> value W1      (dP1)
2 -> value W2      ()
3 -> value W3      ()
    
```

A maximum of 3 more calculating variables can be chosen likewise.

```

*** DEF. CALCULATION ***
          W2
* none
* (K1 - K2)
* K3 - K4
* K5 - K6
* K5 + K6
x: used           ?: fault
    
```

Please take into consideration that the already defined variables are in brackets now (K1 minus K2).



If brackets are displayed without your intention, there might be an operating error. Calculations based on different variables might have been chosen, which are blocked by brackets. Please note that calculations must be based on identical variables.

2.7 Selection of measurable variables for display

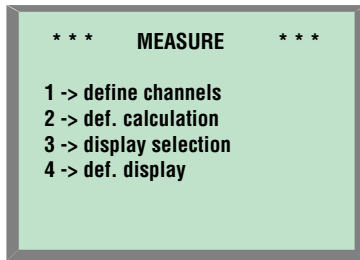

Starting at sub-menu „measure“, press key to enter the next menu „3=> selection display“

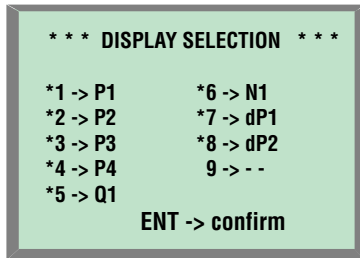

By pressing the corresponding numbers (in this case from 1 to 8) the requested display is chosen and a star symbol will appear in front of each selected number.

2.8 Maximum selection of measurable variables for display

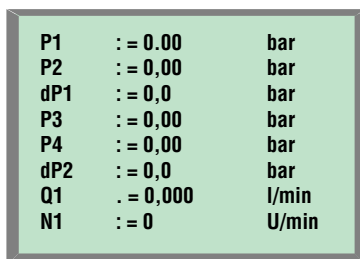

If this selection is confirmed with key , a display with max. eight measurable variables will appear, six of which (pressure p1 to p4, volume flow rate Q1 and rev. speed N1) are taken from the connected sensors. The other two measurable variables are calculated values from the pressure differential:

$$dP1 = p1 - p2 \quad \text{and} \quad dP2 = p3 - p4.$$

2.9 Magnification of display (max. 4 measurable variables)

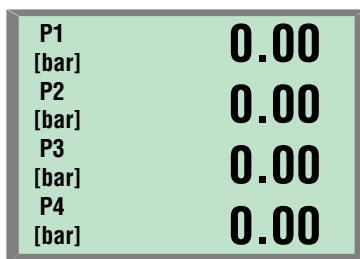

If up to four measurable variables are displayed, the display will be twice its usual size.

With 5 to 8 measurable variables to show, the display will automatically switch to normal size.

2.10 Definition of display for measuring values or min./max. values

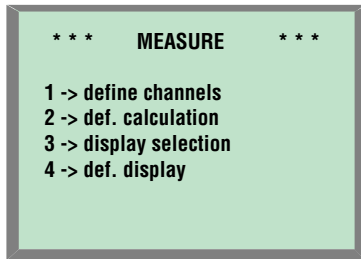

Starting from sub-menu „measure“, the menu “4=> definition display“ is selected with key .

The following display appears:

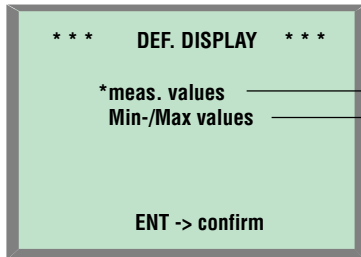

When „measuring values“ is chosen, all current values are displayed (integrated over a second).

To change from the measuring value display to the display of min./

max. values press the corresponding cursor-keys and confirm you selection with key .

2.11 Measuring value display

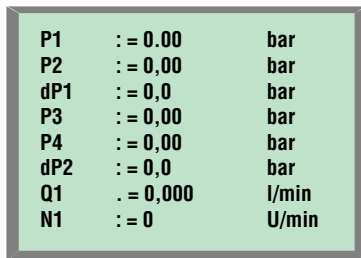

The example shows an 8-line measuring value display.

2.12 Display of min./max.-values

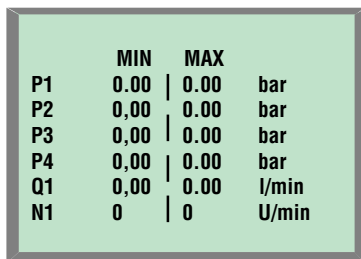

The display of min./max.-values always contains all six measurable variables, but no calculated variables such as differential or sum.

Programme structure when selecting „Programming“

P1	:= 0.00	bar
P2	:= 0.00	bar
dP1	:= 0.0	bar
P3	:= 0.00	bar
P4	:= 0.00	bar
dP2	:= 0.0	bar
Q1	:= 0,000	l/min
N1	:= 0	U/min

Measuring value display:
e.g. pressure P1 to P4,
pressure differential (p1 - p2) and (p3 - p4)
volume flow rate Q1 and rev. speed n1

Prog.

Example "Programming P1"

*** PROGRAMMING ***		
1 -> P1	4 -> P4	7 -> dP1
2 -> P2	5 -> Q1	8 -> dP2
3 -> P3	6 -> N1	9 -> --
0 -> system prog.		

Sub-menu „programming“

You will find all other programming steps
on the following pages:

- T1 (Temperature) page 23
- Q1 (Volume flow rate) page 24
- N1 (RPM) page 28
- dP1 (pressure differential) page 29

Channel 1 to 4

1 2 3 4

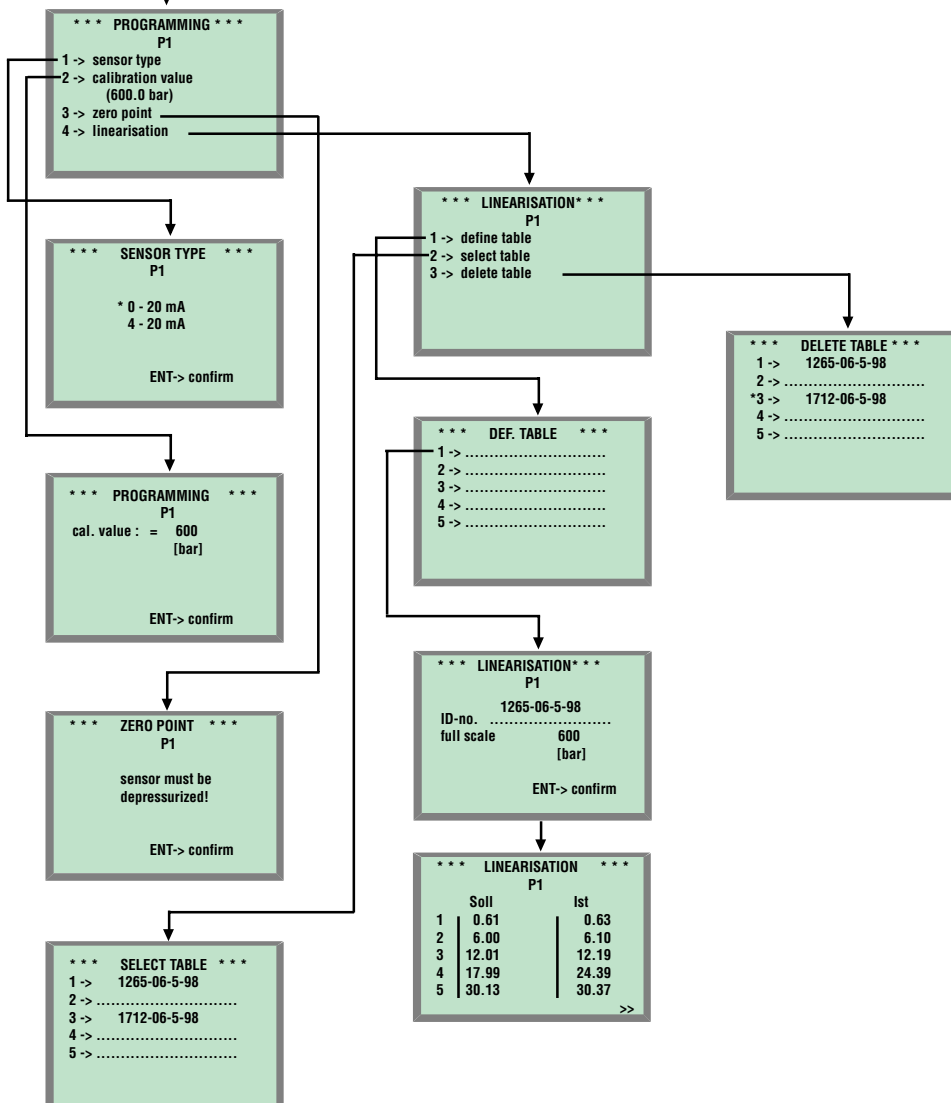

3. Menu „Programming“

P1	: = 0.00	bar
P2	: = 0,00	bar
dP1	: = 0,0	bar
P3	: = 0,00	bar
P4	: = 0,00	bar
dP2	: = 0,0	bar
Q1	. = 0,000	l/min
N1	: = 0	U/min

Starting at the measuring value display, the sub-menu „Programming“ will be selected with key  .

3.1 Programming of analogue channels channel 1 to channel 4

```
*** PROGRAMMING ***
1 -> P1   4 -> P4   7 -> dP1
2 -> P2   5 -> Q1   8 -> dP2
3 -> P3   6 -> N1   9 -> --
0 -> system prog.
```

Now, all measurable variables can be invoked and programmed.

The analogue channels (channel 1 to channel 4) have got an input for signals of 0 to 20 mA and 4 to 20 mA. Programming a calibration value is necessary to adjust the measuring range of a sensor to the signals of 0 to 20 mA and 4 to 20 mA.

In the next example channel 1 is programmed for measurable variable pressure P1.

```
*** PROGRAMMING ***
          P1
1 -> sensor type
2 -> calibration value
      (000.0)
3 -> zero point
4 -> linearisation
```

Press key  to enter the following menu:

3.2 Adjustment of output signal of sensor to 0 to 20 mA or 4 to 20 mA

```
*** SENSOR TYPE ***
          P1
* 0 - 20 mA
  4 - 20 mA
ENT -> confirm
```

By pressing key  the measuring signal of the sensor is adjusted, the display on the left side is shown.

Then press the keys   to choose the desired type of sensor. The type chosen is marked by the star symbol.

With key  the adjustment is stored and the instrument automatically goes back to menu “programming P1”.



When the type of sensor is changed, e.g. for measuring channel (P1) the adjustments of calibration value and the zero point adjustment for that channel are deleted or set at standard values. These values will then have to be programmed again.

3.3 Input of calibration value

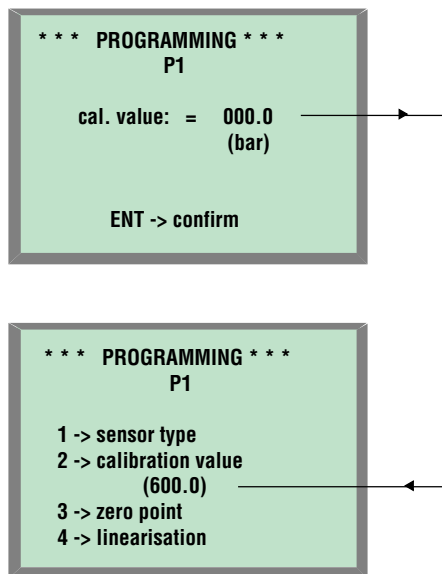

The calibration value corresponds to the pressure range end value of the sensor in use and can be seen from the label of the pressure sensor.

With key the input menu for the calibration value is invoked and the display, shown on the left side, will appear. If the measuring range end value of a pressure sensor is for example 600 bar, the numbers 600,0 need to be entered via the number keyboard.

The input must be confirmed with key .

The menu „Programming P1“ is invoked and the new calibration value (600,0) will be displayed.

When carrying out negative pressure measurements with a pressure sensor from -1 to 6 bar, the calibration value to be entered doesn't relate to the pressure range end value, but to **the span of the pressure measuring range** (from -1 to 6 = **7 bar**). That means, you will have to enter a **7** as a calibration value.

3.4 Zero point alignment for an analogue channel

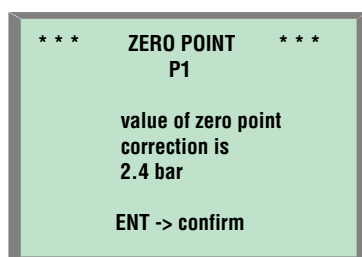
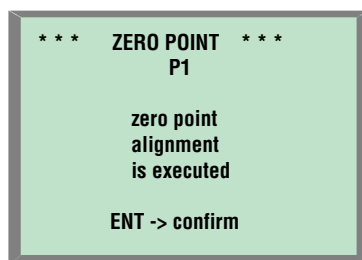
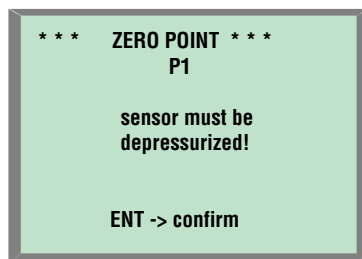

The zero point alignment must be carried out when the pressure sensor is connected and depressurized, otherwise all further pressure measurements will lead to a wrong result.

Press key in menu „Programming P1“ to invoke the zero point alignment. The display reminds you to avoid pressure at the sensor.

With key the alignment is carried out automatically.

For two seconds the display on the left side will be shown. (Zero point alignment is made by integrating two seconds)

Afterwards, the next display will appear with the information, that the zero point alignment has been completed. As an example a deviation of 2,4 bar is indicated.

With key the zero point deviation is stored in the instrument. It will be considered for all future measurements and the display will show correct values.



Please note!

If you have made a zero point alignment for a channel, the corresponding channels for the calculated value: e.g. $W1 = K1 - K2$ are set to zero, too.

3.5 Linearisation

```

*** PROGRAMMING ***
      P1

1 -> sensor type
2 -> calibration value
      (000.0)
3 -> zero point
4 -> linearisation
    
```

```

*** LINEARISATION ***
      P1

1 -> define table
2 -> select table
3 -> delete table
    
```

3.6 Input of a table

```

*** DEFINE TABLE ***

1 -> -----
2 -> -----
3 -> -----
4 -> -----
5 -> -----
    
```

3.7 Assigning of identification numbers for tables

```

*** LINEARISATION ***
      P1

ID.no. 4711-26-2-98
full scale :      600
              (bar)

ENT -> confirm
    
```

3.8 Input of linearisation values

```

*** LINEARISATION ***
      P1 (bar)

REF      ACT
1 | 3      | 2.9
2 | 50     | 49.9
3 | 200    | 198
4 | 400    | 397
5 | 600    | 601 >>
    
```

If no value is entered in a line (actual and setpoint value = 0) input will be stopped. A later correction can be made with the the cursor-keys.

By the linearisation of a sensor a higher measuring accuracy can be achieved. When supplying our sensors, we enclose calibration reports with linearisation tables. You can enter a maximum of five linearisation tables per measuring channel. Each of the tables is related to a certain physical variable so that, for example, a table defined for pressure cannot be used for any other physical variable after having redefined the channel.

Starting at sub-menu „Programming P1“, the programme step „Linearisation“ is invoked with key .

The display opposite will appear. To be able to invoke a linearisation, it is necessary to enter the corresponding values into a table first.

With a stroke of key the next menu is displayed, where a maximum of 5 tables can be entered per channel. In the example table 1 has been chosen with key .

You can enter up to 12 digits (numbers, decimal points and minus) as an identification number (id.-no.). We recommend to enter the serial number of a sensor and the corresponding date, so that each table can be related to a certain sensor later.

As an example, the input of a serial number with date is shown:

4711-26-2-98 (max. 12 digits)

The input is confirmed with key and the second place, where the measuring range end value of the corresponding sensor shall be entered, is flashing.

For the example, 600 bar were entered as a measuring range end value of a pressure sensor.

The input needs to be confirmed with key , too and the next menu step will be displayed immediately.

Now the respective setpoint- and actual values, taken from the calibration certificate of e.g. the pressure sensor, can be entered. It is possible to enter up to 10 sets of values. The input does not have to follow a certain order because the programme will automatically put the values into the correct order after their input.

In the example there is a table with 5 sets of values. If there are more sets of values the programme will automatically move on to the next page. Confirm each input by pressing key .

After completion the „linearisation P1“ programme will appear again.

3.9 Selection of a linearisation table

```
*** LINEARISATION ***
P1
1 -> define table
2 -> select table
3 -> delete table
```

```
*** SELECT TABLE ***
* 1 -> 4711-26-2-98
2 -> -----
3 -> -----
4 -> -----
5 -> -----
```

```
*** PROGRAMMING ***
P1
1 -> sensor type
2 -> calibration value
(000.0)
3 -> zero point
4 -> linearisation
(4711-26-2-98) _ _ _ _
```

Linearisation table is active

You can activate a pressure measurement with linearisation only, after having selected the corresponding table.

The table needs to be invoked with key .

As an example, the table 1 has been chosen with key (please pay attention to the star symbol * !)

In the main menu a message, that the linearisation table is active, will appear.

Now, all pressure measurements will be displayed more precisely.

3.10 Deletion of linearisation table

```
*** LINEARISATION ***
P1
1 -> define table
2 -> select table
3 -> delete table
```

```
*** DELETE TABLE* ***
(1 -> 4711-26-2-98)
2 -> 3316-10-1-98
3 -> 2104-08-1-98
5 -> 2205-22-2-98
```

With key all linearisation tables in menu "Linearisation P1" can be invoked.

To delete for example the tables 2 to 5, you only have to enter the corresponding numbers.



Please note that an activated table cannot be deleted. Is that intended, however, the measuring channel has to be modified to the measuring procedure with calibration value.

In menu „Programming P1“ the calibration value „2-> calibration value“ needs to be invoked and confirmed with key „ENT“ again.

Only then, the table can be deleted; in the example table:

„1-> 4711-26-2-98“

4. Programming of a measuring channel for temperature measurement

```

*** PROGRAMMING ***

1 -> P1   4 -> P4   7 -> dP1
2 -> P2   5 -> Q1   8 -> dP2
3 -> P3   6 -> N1   9 -> --

0 -> system prog.
    
```

```

*** PROGRAMMING ***
      T1

1 -> sensor type
2 -> calibration value
      (0/0 °C)
    
```

```

*** SENSOR TYPE ***
      T1

*0 - 20 mA
 4 - 20 mA

      ENT -> confirm
    
```

A condition for this programming is a re-definition in menu „measure“, as one of the analogue channels 1 to 4 should be adjusted to a temperature measurement „T(°C)“.

With key the menu „Programming“ is selected and in another step „4-T1“ is selected with key .

The opposite display will appear.

The sensor type is invoked with key .

Now the instrument requires the input of the current signal for the temperature sensor.

With the keys the corresponding signal can be chosen and the star symbol shows the selection.

With key the selection is confirmed and the programme automatically goes back to „Programming T1“.

4.1 Adjustment of the temperature measuring range

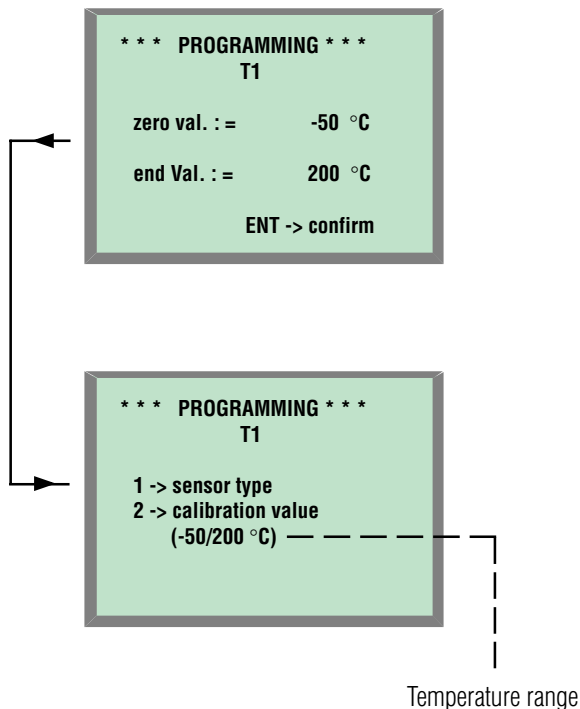

For a temperature sensor not only the measuring range end value, but also the measuring range starting value needs to be entered. As an example a temperature sensor with a measuring range of -50 to 200°C is used.

With key the calibration value is selected and the display on the left side appears. With the keyboard „-50“ is entered as the starting value and „200“ as the measuring range end value.

The input is confirmed with key .

When re-entering the „prog.“ menu the temperature measuring range entered previously, is displayed below the calibration value.

5. Programming of measuring channels for measuring volume flow rate

```

*** PROGRAMMING ***

1 -> P1   4 -> P4   7 -> dP1
2 -> P2   5 -> Q1   8 -> dP2
3 -> P3   6 -> N1   9 -> --

0 -> system prog.

```

5.1 Selection of measuring principle

```

*** PROGRAMMING ***
      Q1
1 -> turbine/GFM
2 -> orifice gauge
      (type A3)

      ENT -> confirm

```

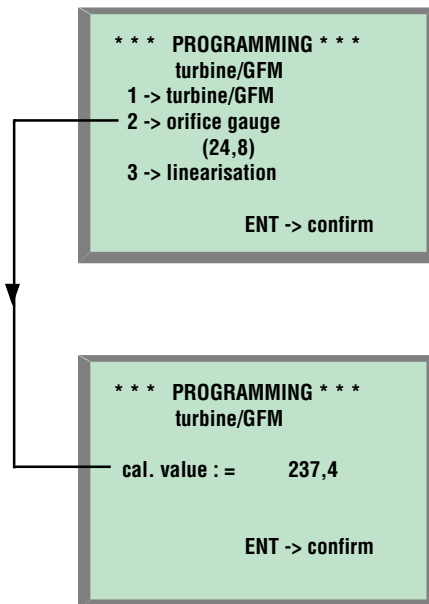

5.2 Volume flow rate measurement with higher accuracy through input of linearisation values

```

*** PROGRAMMING ***
      turbine/GFM
1 -> sensor type
2 -> calibration value
      ( 237,4)
3 -> linearisation

      ENT -> confirm

```

The channels 5 and 6 are designed to carry out measurements of volume flow rate with frequency signals for turbines and gear flow meters.

With key the menu „Programming“ is selected, in which „5 -> Q1“ is selected with key .

The following menu for the selection of turbine/gear wheel or orifice gauge is shown and as an example, „turbine“ is selected with key .

The next menu appears immediately afterwards.

The standard procedure does not require „1=> type of sensor“ (This input is only necessary for special types). For the measurement with volume flow rate sensors, the input of a calibration value is imperative, too. It can either be seen on the label of the sensor, or it can be taken from the calibration certificate, that is enclosed to the sensor delivered.

Press key , then enter the value from left to right (incl. decimal point where needed). The old value will be overwritten.

With key the input is completed.

When measuring with turbines, a higher accuracy can be achieved by the input of a linearisation table. The corresponding value can be taken from the calibration certificate.

Input and correction can be carried out as is the case with the analogue channels (pressure). However, in this case, frequencies and the corresponding flow rates should be entered as value sets.

Starting at menu „Programming turbine/gear wheel“, the linearisation is invoked with key .

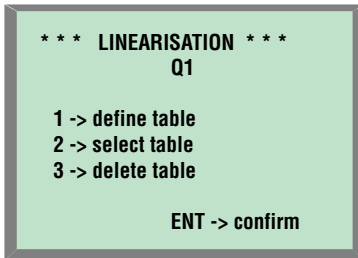

5.3 Input of a table

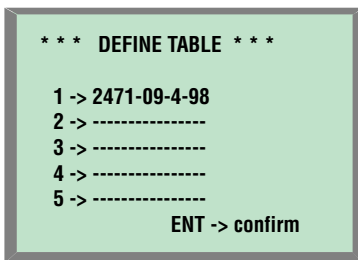

5.4 Assigning an identification numbers for the table

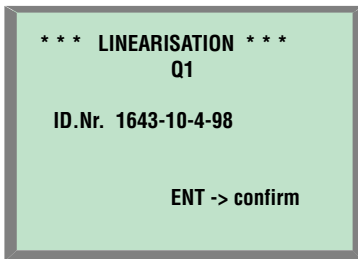

5.5 Input of linearisation values

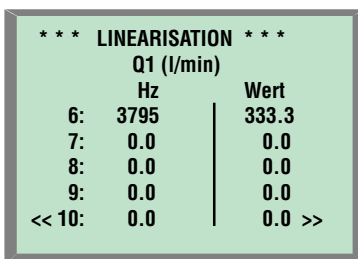
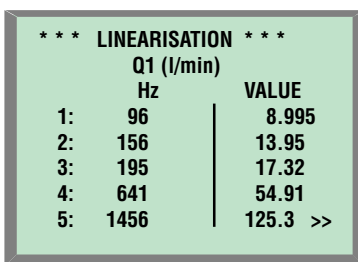

The following display appears.
If no inputs were made previously, a table needs to be fixed, first of all.

This is made with a stroke of key .

The next menu step will be displayed.

As an example, table 2 is selected with key and the next step will be displayed automatically.

We recommend to enter the serial number of the turbine and the corresponding date, so that each table can be related to a certain turbine later.

As an example, the input of a serial number with date is shown:

ID.Nr. 1643-10-4-98

The input is confirmed with key . You can enter up to 12 digits (numbers, decimal points and minus) as an identification number (id.-no.).

In the next display the value sets must be entered. The frequency in Hz and the value in l/min. can be taken from the calibration certificate. It is possible to enter up to 10 sets of values. The input does not have to follow a certain order because the programme will automatically put the values into the correct order after their input. That means, corrections or a later addition of values is always possible.



In the example there are six sets of values, according to the calibration certificate, the seventh value isn't necessary.

To stop the process earlier, enter 0 for both "Hz" and "value" in the seventh value and confirm with .

Please note that there is a maximum of 5 linearisation tables per channel.

5.6 Selection of linearisation table

```

*** LINEARISATION ***
      Q1

1 -> define table
2 -> select table
3 -> delete table

      ENT -> confirm
    
```

To achieve a precise volume flow rate measurement, a corresponding linearisation table can be selected.

Press key to invoke the selection of a table.

```

*** DEFINE TABLE ***

*1 -> 2471-09-4-98
2 -> 1643-10-4-98
3 -> -----
4 -> -----
5 -> -----

      ENT -> confirm
    
```

In the example table 1 or 2 can be chosen. In this case table 1 is chosen with key and a star symbol appears in front of the selected table.

Pressing key brings you back into the „Linearisation Q“ programme.

```

*** PROGRAMMING ***
      turbine/GFM
1 -> sensor type
2 -> calibration value
3 -> linearisation
      (2471-09-4-98)

      ENT -> confirm
    
```

In point „3 -> linearisation“ the programme informs, that the linearisation is activated (2471-09-4-98).

5.7 Deletion of linearisation tables

```

*** LINEARISATION ***
      Q1

1 -> define table
2 -> select table
3 -> delete table

      ENT -> confirm
    
```

Press key to invoke the linearisation table from the previous menu „Programming turbine/gear wheel“. The opposite display appears.

With key , the linearisation tables from another menu are invoked.

```

*** DELETE TABLE ***

(1 -> 2471-09-4-98 ) — active
2 -> 1643-10-4-98
3 -> -----
4 -> -----
5 -> -----

      ENT -> confirm
    
```

As table 1 is still activated, what can be seen by the brackets, only table 2 can be deleted. Press key , the star symbol appears and with key table 2 is deleted.



If table 1, indicated in the example, shall be deleted, enter a calibration value first. Please take into consideration, that the Multi-System 5000 always requires a value: either the linearisation table or the calibration value.

6. Volume flow rate measurement with orifice gauge (measuring pressure differential with pressure sensors)

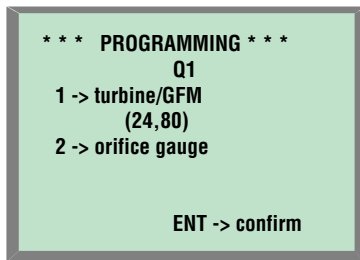

6.1 Selection of orifice gauge type

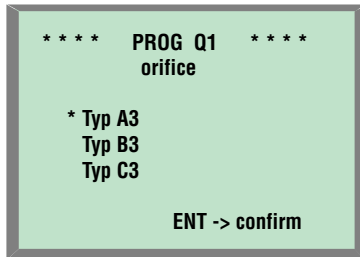

6.2 Alignment of an orifice gauge

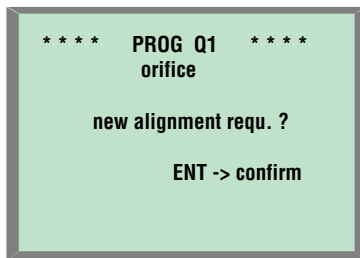

6.3 Connection scheme of an orifice gauge

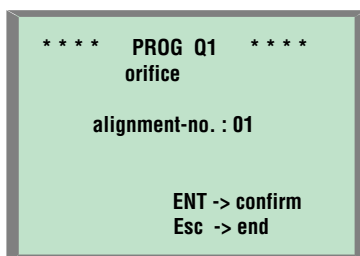
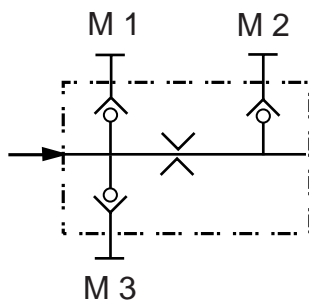

Please take into consideration that measuring with an orifice gauge can only be carried out via channels 1 and 2 (measuring pressure differentials). Pressure sensors must be connected to channels 1 and 2.

Starting at that menu, press key to invoke orifice gauge. The next step is displayed immediately.

Using the keys , the type of orifice gauge can be selected and the type chosen is marked by the star symbol. Press key to confirm your selection.

The following types of orifice gauges can be chosen:

type A3 : 10 to 50 l/min
 type B3 : 40 to 210 l/min
 type C3 : 120 to 600 l/min

The type and the measuring range of an orifice gauge can be seen by its label. At the initial use an alignment is always necessary.

For further measurements an alignment may be optional under certain circumstances.

The accuracy of a measurement with orifice gauge depends on the largest achievable accuracy of a pressure differential measurement. This is achieved by an alignment of both pressure sensors at the same pressure level. To get a satisfying result for the complete measuring range, both pressure sensors can be aligned to 10 different working pressure situations and the corresponding values can be stored within a single measuring range. This increases the accuracy within a flow rate measuring range. The internal software considers the dependence of the root of the pressure drop related to the flow, adds all alignment parameters and calculates the volume flow rate, e.g. in l/min.

In practice an alignment is carried out as follows:

Both pressure sensors are to be connected to the respective measuring points M1 and M3 (see connection scheme). It serves the purpose best if the maximal possible flow or the highest possible working pressure is achieved to carry out the alignment. This is necessary, if only one alignment is carried out.

The errors of each sensor are set to zero at the alignment. At the same time deviations depending on temperature, like linearity-, long term- and temperature drift errors are suppressed efficiently.

The alignment is carried out by pressing key .

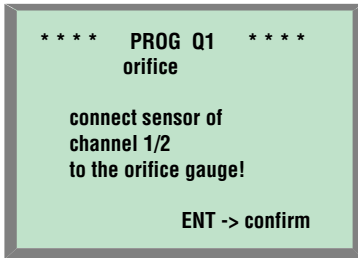

After the alignment the pressure sensor is removed from measuring point M3 and connected to M2.

When the alignment is finished or interrupted, the following display appears.

To activate measurement with orifice gauge, press key .

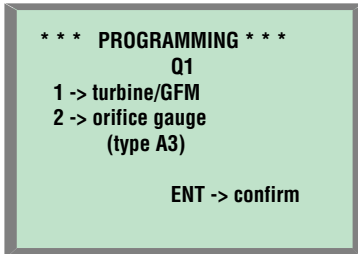

The following menu appears, showing that the orifice gauge is activated.

7. Measurement of RPM

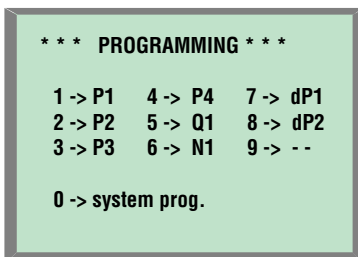

To measure RPM, the number of pulses per revolution must be entered into the instrument as a number. When using an optical rev. speed probe, only one reflection marking should be stuck on the rotating part to be measured.

For the acquisition of RPM at a gear ring with inductive rev. speed sensor (amplifier output) the number of teeth must be entered into the measuring instrument.

The channels 5 or 6 can be used for a RPM-measurement (frequency measurement).

Press key to invoke display „programming“. As an example, no. 6 -> N1, is chosen and confirmed with key afterwards.

7.1 Input of pulses per revolution

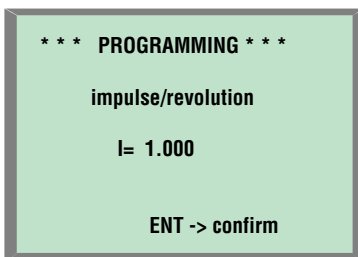

The following menu appears into which one pulse per revolution is entered for an optical rev. speed probe as an example.

The input needs to be confirmed with key and the measuring value display will be shown again.

Please note: If RPM measurements below **60 min⁻¹** are requested, this can be realized by sticking on several reflective foils. Remember to change the input of pulses per revolution in any case.



When using one reflective marking, the RPM measuring range for an optical rev. speed probe is between 60 min⁻¹ and 30,000 min⁻¹.

8. Precise pressure differential measurement by programming additional calculation of two measuring channels

8.1 Connection scheme of a pressure differential measurement

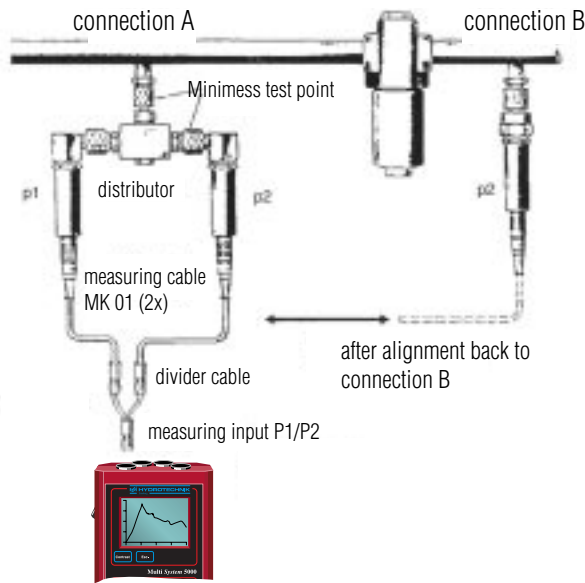

8.2 Definition of calculation variables for a pressure differential measurement

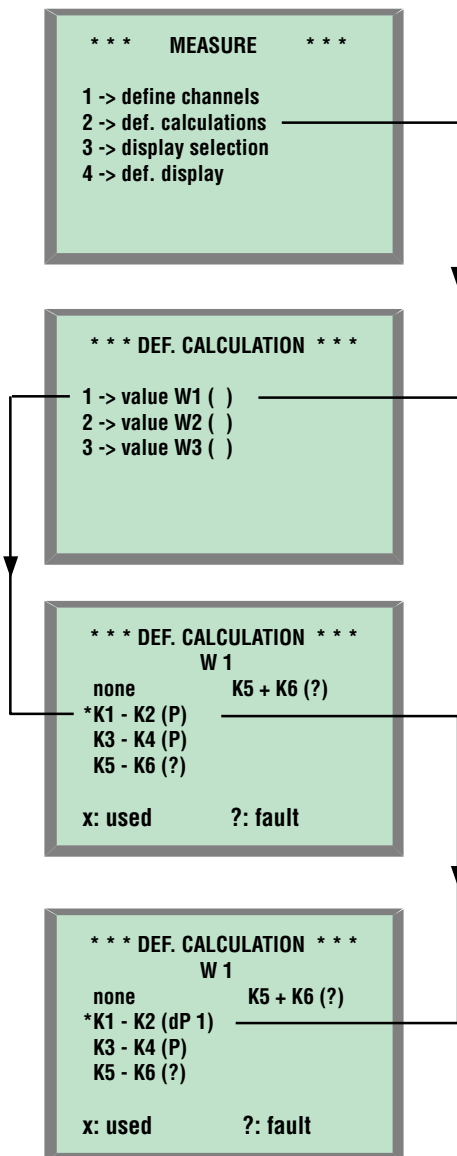

The precise measurement of pressure differential is only possible, if both pressure sensors were aligned at the same working pressure, with which you want to measure later.

In the following example the connection of both sensors is described:

Sensors P1 and P2 must be connected to an identical pressure level at connection A via a distributor. Both measuring cables MK01 are connected with sensors P1 and P2 and via distributing cable with inputs K1/K2 (P1/P2).

Afterwards, the instrument needs to be adjusted as follows: In the example, the measuring channels 1 and 2 are used for the pressure measurement.

With key the pressure for channel 1 and 2 needs to be defined in bar (1-> Def. measuring channels, see previous description).

In another step the calculation value W1 is adjusted (2-> Def. calculation, see previous description).

After the adjustment with the cursor keys, the channels 1 and 2 are selected (P1-P2), what can be seen by the star symbol in front of K1.

Press to activate the calculated variable. This can be seen clearly in the next menu step in line „K1-K2 (dP1)“.

```

*** PROGRAMMING ***
1 -> P1   4 -> P4   7 -> dP1
2 -> P2   5 -> Q1   8 -> --
3 -> P3   6 -> N1   9 -> --

0 -> system prog.

```

The following menu is invoked with key  .

With the input of the number „7“, the programme will be activated for the zero point alignment of both pressure sensors at the preset working pressure.

8.3 Alignment of both pressure sensors at identical working pressure

```

*** PROGRAMMING ***
dP 1
alignment of both
sensors with the
same pressure!

ENT-> confirm

```

The menu on the opposite side appears.

Press key  to start the alignment process. The two measured pressures are levelled out by calculating their mean value. As this alignment suppresses deviations of sensors, temperature drifts and offsets, it makes precise pressure differential measurements possible.

Deviations are displayed automatically as correction values during the next step.

Press  to go back to the measuring value display.

```

*** PROGRAMMING ***
dP 1
dP- correction
value is

1.2 bar

ENT-> confirm

```

Pressure sensor P2 must be mechanically connected to measuring point B after the alignment. Then extremely precise measurements, as required for load-sensing-procedures, can be carried out.



Please note that pressure differentials are only displayed with correct signs, if the higher pressure is connected to sensor P1 (difference = P1-P2).

If sensors are connected vice versa, a negative pressure differential will be displayed.

You can connect pressure sensors with different measuring ranges, but in doing so, you should always pay attention, that the maximal nominal pressure of the sensor isn't exceeded (Use of sensors with different measuring ranges is possible but maximal pressure for each sensor should not be exceeded (pressure burden !).

9. System adjustments

Language, date, time and interface RS 232

```
*** PROGRAMMING ***  
  
1 -> P1   4 -> P4   7 -> dP1  
2 -> P2   5 -> Q1   8 -> --  
3 -> P3   6 -> N1   9 -> --  
  
0 -> system prog.
```

Besides the programming of physical measurable variables, there are also languages (German, English, French), time, date and interface RS 232 that can be defined.

Press key  and enter number „0“ to invoke respective display.

9.1 Adjustment of language

```
*** SYSTEM PROG ***  
  
1 -> language  
2 -> date/time  
3 -> RS 232
```

With the input of number „1“ the menu for selecting the operating language is invoked.

```
*** SYSTEM PROG ***  
language  
  
* german  
  english  
  french  
  
ENT -> confirm
```

With the keys   the requested language can be selected and confirmed with key .

9.2 Adjustment of date and time

```
*** SYSTEM PROG ***  
clock  
  
date: 16/04/98  
time: 14:31  
  
ENT -> confirm
```



With number „2“ the time programming is invoked. An input is possible, when the line is flashing.

A correction of the input is made with cursor key  by simply overwriting the previous input.

Press  to start internal clock.

9.3 Adjustment of Baud rate for interface 232

```
*** SYSTEM PROG ***  
RS 232  
9600 Baud  
19200 Baud  
* 38400 Baud  
radio  
  
ENT -> confirm
```

Enter number „3“ to invoke the adjustment of Baud rate. With the cursor keys  and  the desired Baud rate *)

can be selected and confirmed with key  afterwards.

*) Baud (bd) means bits/s and is the unit for transmission speed. We recommend the following Baud rates:

HYDROcomsys/DOS-software package (from DOS 4) = 38400 Baud
HYDROcomsysWin/windows version = 19200 Baud



10. Menu Memory

10.1 Carrying out an optimal storage

With its programmable parameters Multi-System 5000 (from version 2.5 onwards) offers a variety of options for carrying out storage proceedings. Before storing, you should know exactly, how to carry it out optimally for your purposes.

From version 2.5 on, there is an extended memory available (max. 250,000 values) for newly purchased instruments - in addition to the standard memory (max.120,000 values).

This larger memory capacity can tempt to carry out a detailed storage with a scanning rate of e.g. 1 ms over a long period of time. However, this cannot be recommended because the memory would be filled with unnecessary data.

You should rather select a certain part (window) at a measuring cycle by selecting scanning rate, storage time, type of trigger and pretrigger adjustment, to obtain a certain excerpt (window) of a measuring circle, as in this case, only a fraction of all measuring data has to be stored.

The following explanations shall help you to find your optimal adjustment of the storage parameters:

10.2 Memory channels

You should select only those channels (variables) which are really needed for the respective measuring task. Please take into consideration that unnecessary data that is activated when storing, needs a lot of storage capacity and may reduce the processing speed considerably. Nevertheless it is, of course, possible to correct or delete unnecessary measurable variables with the instrument as well as via the software HYDROcomsys.

The timely selection of measurable variables to be stored avoids possible restrictions of the memory capacity and the processing speed in advance.

10.3 Scanning rate

This parameter fixes the duration of storage. In connection with the scanning rate the number of measuring value sets to be stored is defined at the same time. A measuring value set can consist of one or several measuring values related to different measurable variables. The measuring values are stored as a measuring value set at one single point of scanning.

For clarification and better understanding, please see the following example:

The measurable variables pressures P1 and P2 and temperature T shall be stored.
A scanning rate of 1ms and a storing time of 5 seconds is defined.

Consequently, 3 measurable variables are stored per scanning (1ms).

After a storage time of 5 seconds 5.000 sets of measuring values, i.e. 25,000 individual values, are stored.

The measuring values of one storage are called data file.

Max. 20 data files can be stored in the Multi-System 5000 and each data file may consist of many measuring value sets.

The storing time is comparable to a window, reflecting a certain section of time of a measuring process. You should select a sufficient length of storing time to show all desired results but to leave out most of the irrelevant details.

Max. 6 measuring values can be stored simultaneously. The memory capacity is app. 250.000 measuring values and can be divided into 20 storage locations. The division, how many measuring values are stored to one storage location, depends on the input of the storage parameters.

The storing time is comparable to a window, reflecting a certain section of time of a measuring process. You should select a sufficient length of storing time to show all desired results but to leave out most of the irrelevant details.

10.4 Invocation of memory

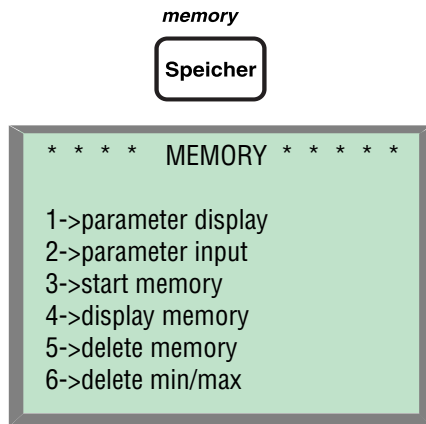

Max. 6 measuring values can be stored simultaneously. The memory capacity is app. 250.000 measuring values and can be divided into 20 storage locations. The division, how many measuring values are stored to one storage location, depends on the input of the storage parameters.

Press key "memory" to invoke the storage parameters.

The following menu will appear. We recommend to select „-> input parameters“ first of all.

With a stroke of key „2“ you can get there.

10.5 Calling parameters

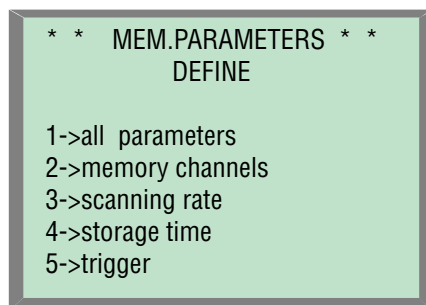

For the first measurements you should select „all parameters“. All necessary steps are displayed automatically and an input is imperative before the programme moves on. Thus, no step can be forgotten. Once you are familiar with the instrument, all inputs can be selected and all necessary parameters can be entered individually. Each input must be confirmed with key „ENT“. Press key 2 to select the memory channels to be stored.

10.6 Selection of measurable variables for storage

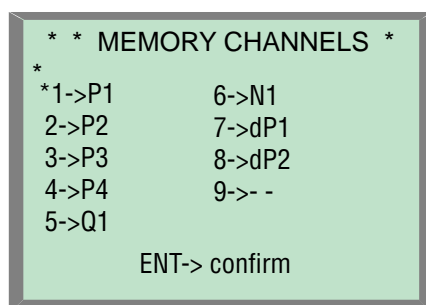

As an example, the pressure channel P1 is invoked with key „1“. The star symbol appears in front of P1 and shows that this channel is selected. With key „ENT“ you will get into the next menu step.

10.7 Definition of scanning rate

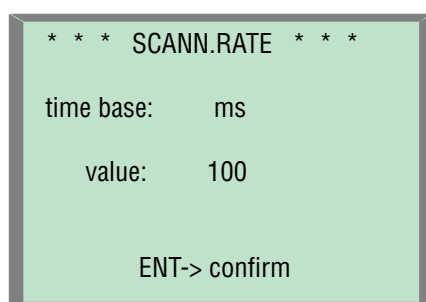

In this menu for the definition of the scanning rate, the input to be made flashes.



Use the cursor-keys   to select ms, sec. or min.

As an example, ms are chosen and confirmed with key „ENT“. Then, the time-value to be entered flashes.

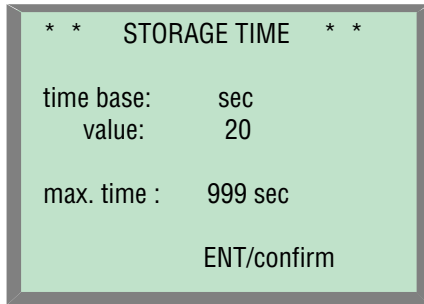
10.8 Definition of storing time



In the next menu step, the duration of a storage can be entered.



With the cursor-keys   you can select h, min or sec.

In the example a storing time of 20 sec. is chosen. Please, confirm each input by „ENT“. After input of the requested time basis, the max. possible storage time that can be entered as a value, will be displayed.

The next menu step for the adjustment of the trigger will be shown automatically.

11. Selection, adjustment and application of the trigger

In menu „TRIGGER“ you can select 4 different trigger types, which are described below.

With one of the cursor-keys   , the trigger type can be chosen. The example shows the four different trigger types that can be invoked with the cursor keys.

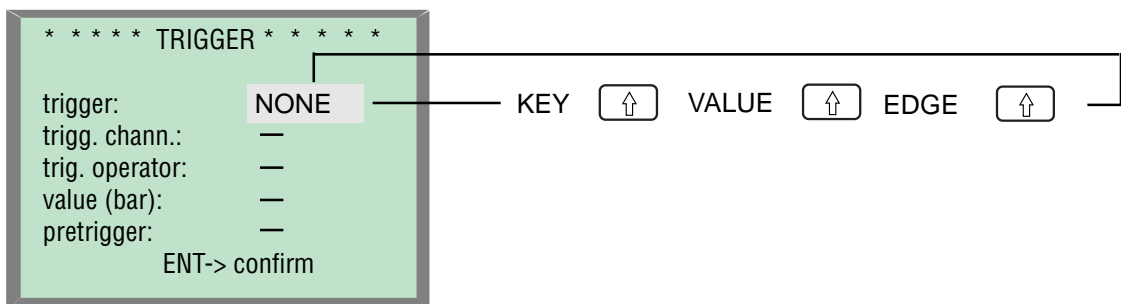

11.1 Trigger type „NONE“

If „NONE“ is selected, no trigger will be used and no further input is required.

The following storage works as follows: after the selection of „memory start“ and input of a group of max. 12 figures , press „ENT“ to prepare storage. In the menu „Measuring value“ a bar is shown, that indicates the state of the storage, and that, in this case, remains unaltered. The selected memory variables are **not marked** by the star symbol.

Only by pressing key  you will start the prepared storage, it starts and ends according to the programmed storage time.

To interrupt the process at any time, press key  . In doing so, remaining storage capacity is released and available for future storage.

11.2 Trigger type „KEY“

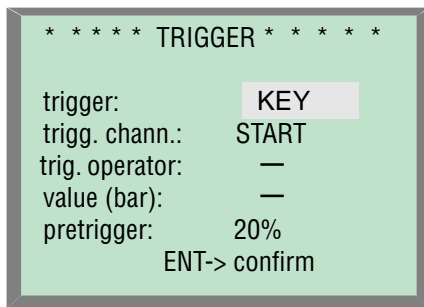

With key  the trigger type „KEY“ is selected. In the next line of the display no measurable variable, but key „Start“ is defined automatically. Additionally a pretrigger can be adjusted, 20% in this example.



A storage is carried out as follows:

The size of a memory range has already been defined with the input of storage time, scanning rate and memory channels. After selection of „memory start“ and input of a group of max. 12 figures, key „ENT“ needs to be pressed and the storage is activated immediately. The measuring values of the selected channels are stored.

As soon as the end of the reserved memory range is reached, the oldest data at the beginning of the memory is overwritten, what means that it is a ring type memory. In the measuring value menu a bar is displayed, that shows the state of the storage.

A flashing star symbol is displayed in front of the variables to be stored. In the example the bar-graphic shows a storage of 20%, according to the pretrigger adjustment of 20%. If you press key  at any time, the rest of the data (80%) is stored, the bargraph is completed, the star symbol stops flashing the storage is finished automatically after the fixed storage time. With key  the storage can be interrupted any time.

11.3 Trigger type „VALUE“

With key  the trigger type „VALUE“ is selected. A measurable variable needs to be defined as a trigger variable, in the example this is pressure p1. In this case, the trigger operator is adjusted to „larger“ >. That means, the value of 150 bar, entered afterwards, must be exceeded to start the trigger and the storage.

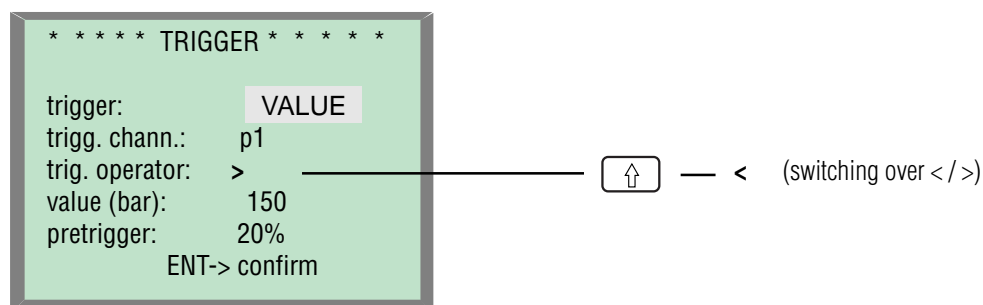

A storage is carried out as follows:

The size of a memory range has already been defined with the input of storage time, scanning rate and memory channels. After selection of „memory start“ and input of a group of max. 12 figures, key „ENT“ needs to be pressed and the storage is activated immediately. The measuring values of the selected channels are stored.

As soon as the end of the reserved memory range is reached, the oldest data at the beginning of the memory is overwritten, what means that it is a ring type memory. In the measuring value menu a bar is displayed, that shows the state of the storage.

A flashing star symbol is displayed in front of the variables to be stored. In the example the bar-graphic shows a storage of 20%, according to the pretrigger adjustment of 20%. If the measuring value P1 of 150 bar is exceeded at any time, the rest of the data (80%) is stored, the bargraph is completed, the star symbol stops flashing the storage is finished automatically after the fixed storage time.

This example can be inversed. That means, if a storage shall be carried out when the value falls below 150 bar (the measuring value p1), the trigger operator just needs to be adjusted to „smaller“ <.

With key  the storage can be interrupted any time.

11.4 Trigger type „EDGE“

With key  the trigger type „EDGE“ is selected.

```

* * * * * TRIGGER * * * * *
trigger:      EDGE
trigg. chann.: p1
trig. operator: >>
value (bar):  100
pretrigger:   80%
              ENT-> confirm
  
```



← << (adjustment of edge in rising/falling)

A measurable variable needs to be defined as a trigger variable, in the example this is pressure p1. In this case, the trigger operator is adjusted to „rising“ >>. That means, the value of 100 bar, entered afterwards, must be exceeded as a rising edge to start the trigger, what means that the trigger is started by an edge. To apply this triggering the other way around, the trigger operator must be adjusted to „falling“ << and the storage will be started when the measuring value falls below 100 bar. The following should be considered for the trigger type „EDGE“:

Example of a edge triggering

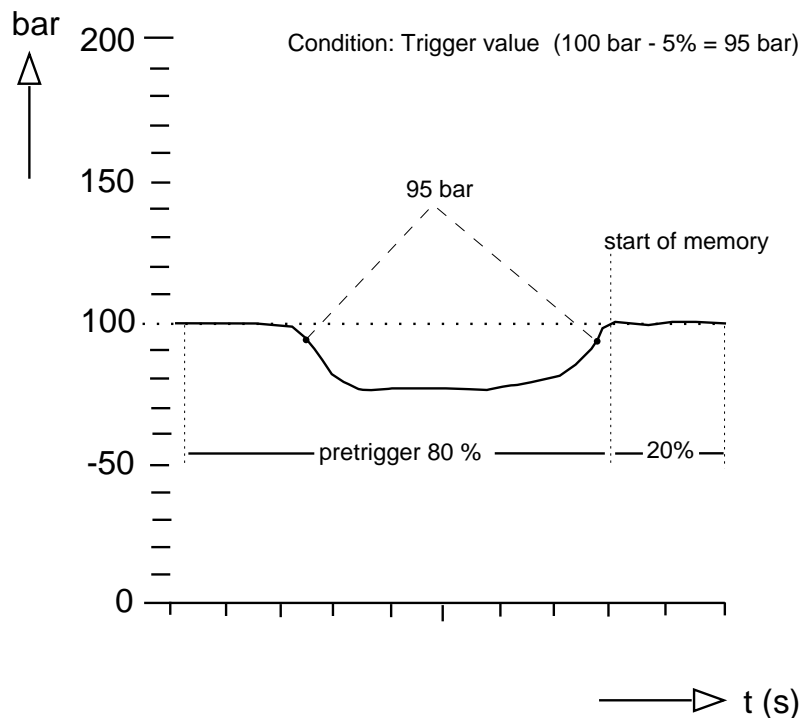

trigger	edge
trigger chann.	p1
trigg. operator	>>
value (bar)	100
pretrigger	80%

With a rising edge, the trigger channel, in the example $p1 = 100$ bar, must have a measuring value 5% lower than the trigger value ($100 \text{ bar} - 5\% = 95 \text{ bar}$). The next exceeding of the trigger value of 100 bar will start the trigger.

When a falling edge is adjusted, (trigger operator <<) the procedure works exactly vice versa. First of all the measuring value must be 5% higher than the trigger value (100 bar). The next measuring value below 100 bar will then start trigger. This hysteresis of 5% was introduced to avoid an unwanted storage, caused by measuring values near the trigger value, e.g. when A/D converter deviates by 1 bit.

11.5 Display and function of the pretrigger for internal and manual triggering

When triggering internally (VALUE, FLANK) the trigger point depends on the adjustment of the threshold value (here: >150 bar). When the measuring signal falls below/exceeds the threshold value, a storage is started automatically and according to the pretrigger adjustment a certain percentage of history will be stored.

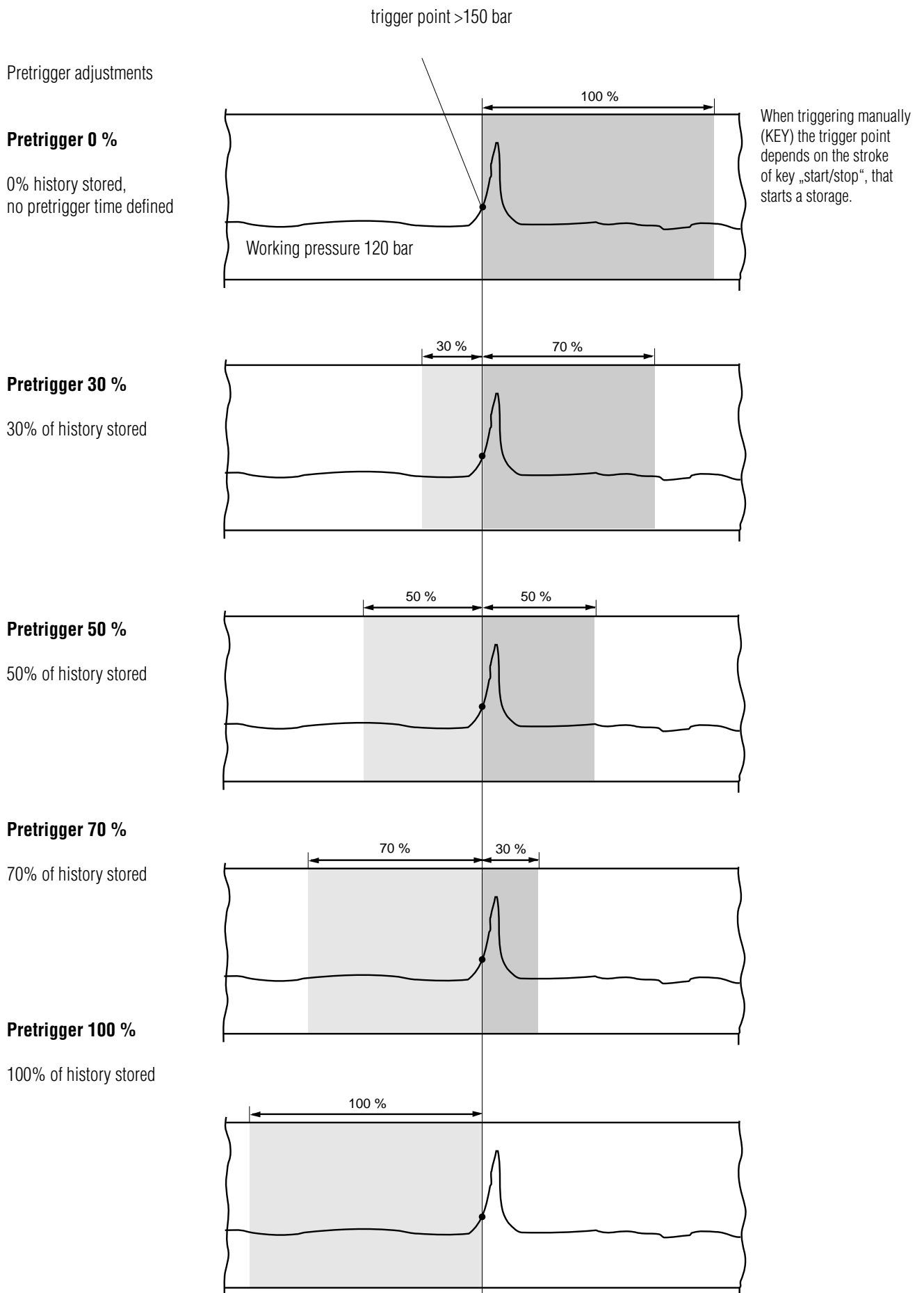

To obtain a stored data file, that really fulfils your requirements regarding the storage before and after the triggering, it is necessary to consider a few conditions for the manual and the internal triggering:

The trigger must not be activated unless instrument has had the opportunity to store the corresponding measuring values before.



Please note: Your pre-trigger adjustment can be changed in 1% steps from 0% to 100%

In the examples mentioned-below, the different effects of the pretrigger are explained in more detail.

Examples of a storage of 20 s with pretrigger adjustment 20% and threshold value adjustment 150 bar and its effect on the measuring value storage.

The following parameters were adjusted: storage time 20 s, pretrigger 20 %, time base 100 ms, input of the trigger threshold value: > 150 bar (examples on the left) or <150 bar (examples on the right)

Ideal measuring value storage
Trigger event after 4 s,
Remaining storage time 16 s,
all measuring values are acquired in a
storage time of 20 s.
Different effects of the storage when
adjusting the trigger point to >150 bar
or <150 bar.

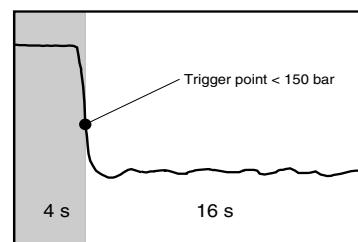
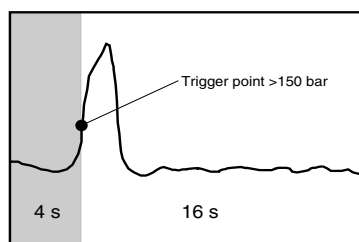

Ideal storage with pretrigger from 4 s and remaining storage time of 16 s. The measuring instrument had enough pretrigger time to store the time before the trigger.

Trigger event after 2 s,
Storage time 18 s

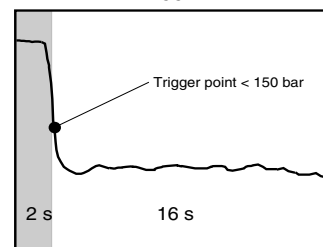
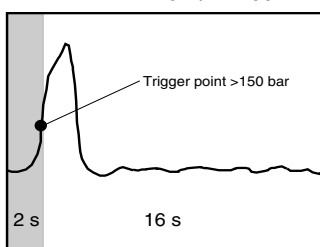

Triggering already starts after 2 s (too early), that is why 50% of the time before the trigger are not stored. In this case you only have to modify the pretrigger adjustment.

Trigger event immediately,
Storage time 16 s

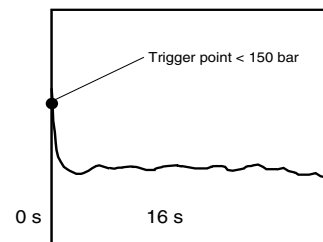
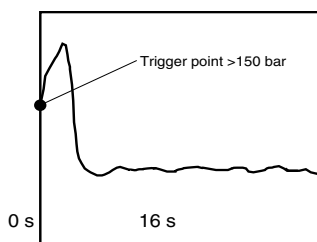

Triggering starts immediately, the measuring instrument has no time (pretrigger time) to store the time before the trigger.

The following examples demonstrate an improper storage of measuring values.

When measurements are stopped early, i.e. before the end of a complete measuring time or during the pretrigger phase already, an interpretation or discussion of a measuring value display becomes impossible with regard to the adjusted memory- and trigger parameters.

Interrupt with key "Start/Stop"

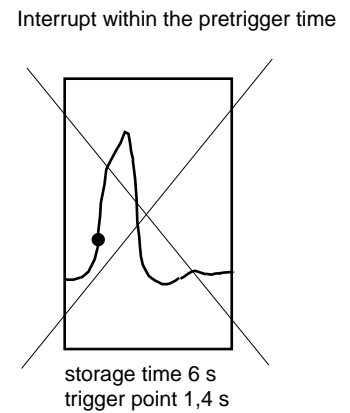
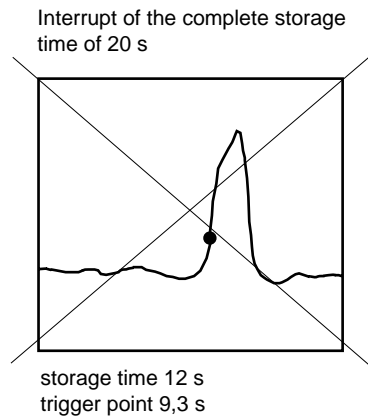

11.6 Trigger adjustment „VALUE“

```

* * * * * TRIGGER * * * * *
trigger:          VALUE
trigg. chann.:   P1
trig. operator:  >
value (bar):     100.0
pretrigger:      20%
                  ENT-> confirm
    
```

The example shows the trigger adjustment „VALUE“.

After having checked your inputs again, press key „ENT“ to confirm the inputs.

```



* * MEM.PARAMETERS *
chann.: P1
scann.rate: 10 ms
storage time: 2 sec
trigger:     VALUE
                >>
    
```

With key „1“ the menu „display parameters“ is invoked, then menu „memory parameters“ appears and all entered parameters are automatically displayed.

Please note the arrows >> at the bottom right hand corner of the display, they mean, that a further page exists in the display.

```

* * MEM.PARAMETERS * *
trigg.chann.:   P1
trig. operator: >
value (bar)    100
pretrigger:     20%
                <<
    
```

To go there, press one of the keys   , and use the same keys again to return to the previous page.

11.7 Start memory

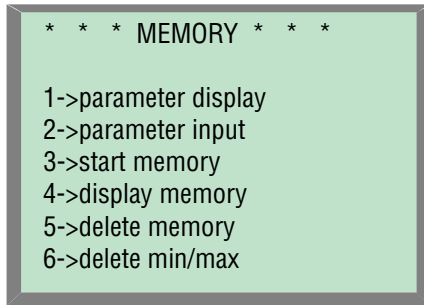

If all inputs were carried out correctly, the menu „memory“ is invoked with another stroke of key „ENT“ and afterwards, „Start memory“ is invoked with key „3“.

11.8 Fix memory name

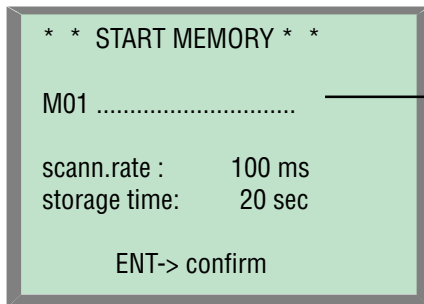

Position MO1 flashes and requires the input of an identification number, which should be meaningful to you, so that you will be able to find the stored data again later.

Storage locations are allocated automatically, there are 20 storage locations available.

12 digits can be entered as a number, which could look as follows:

M01 16,4,1998-01
 (date and measurement 01)

If you enter nothing, the instrument will automatically allocate an identification number consisting of date and time

e.g. 16 04 98-15:43

Identification numbers may consist of figures, decimal points and hyphens. The confirmation with key „ENT“ starts the immediate storage and the menu „memory“ is invoked.

Another stroke of key „ENT“ leads to the measuring value display.

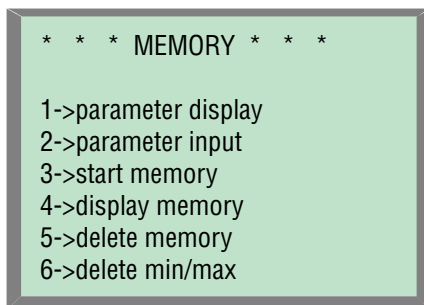

11.9 Active memory display

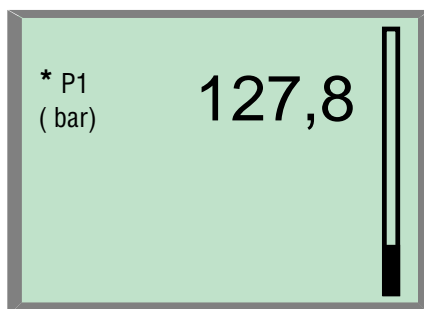

On the right side of the measuring value display a bargraph shows the current state of a storage.

This bargraph will help you to carry out a correct storage of measuring values as it recognizes the waiting position of the pretrigger and is able to start the manual triggering (trigger type „KEY“ with key „start/stop“).

For the internal triggering (VALUE or FLANK) this process is started automatically by the programmed measuring signal. The flashing star symbol indicates that the storage is active and that data is permanently stored in the background.

As long as no triggering occurred, the bargraph stops rising at approx. 20% and the star symbol continues flashing (in the example a pretrigger of 20% was chosen).

If the end of the reserved memory range is reached, the oldest data at the beginning of the memory are overwritten, what means that it is a ring type memory. In the measuring value menu the bargraph shows the state of the storage.

For better understanding of the storage:
 scanning rate 10 ms, storage time 2s,
 pretrigger 20%, (80% after triggering)
 and measuring value p1.
 After the triggering another 160 sets
 of measuring values are stored
 (80% of max. 200 measuring value sets).

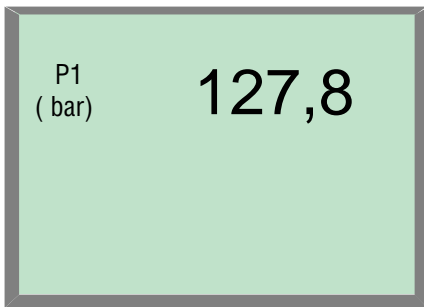

As soon as a triggering takes place, e.g. when the measuring signal exceeds the threshold value (in the example > 100 bar), the bargraph will slowly rise and the star symbol will stop flashing.

When the bargraph is completed, the storage will automatically be stopped and the bargraph will disappear.

Stored data can be displayed, printed out or transmitted directly to a PC as a course of curves.

11.10 Display memory

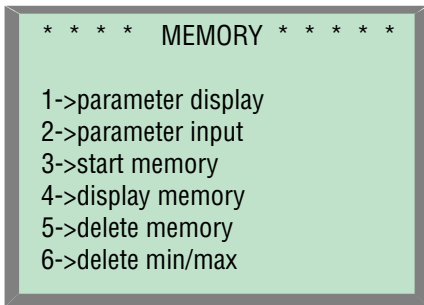

With key memory the basic menu „Memory“ and with key „4“ the menu for the display of the memory is invoked, afterwards.

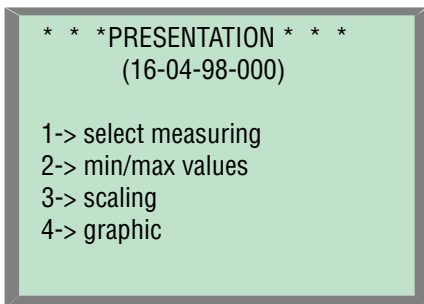

A data file (16-04-98-000) is already selected in the menu, to select further data files, please enter „1“.

11.11 Select stored data file

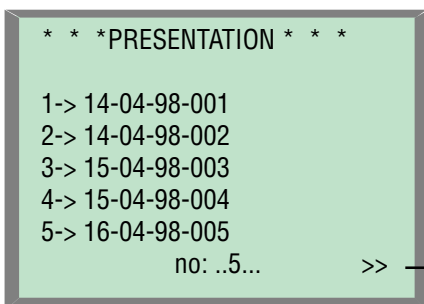

A menu with all data files, already stored, is displayed. The >> symbol at the bottom right-hand corner indicates that there are several pages, which can be selected with the cursor keys. A maximum of 4 pages with 5 data files, each, can be displayed. The corresponding number needs to be entered into field „No. ...“ and key „ENT“ must be pressed to confirm.

11.12 Determination of the min./max. values of a data file

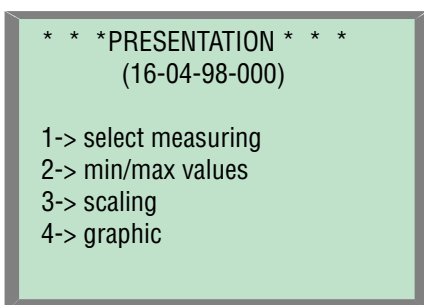

As an example no. 5 is selected. The previous menu with the identification number 16-04-98-005 is displayed immediately.

Enter „2“ to have all min./max. values of that data file displayed.

```

* * * * 16-04-98-005 * * * *
variable  MIN      MAX

      wait
      (calculation)
      65%

      ESC-> end

```

11.13 Display of the min./max. values of a data file

```

* * * * 16-04-98-005 * * * *
variable  MIN      MAX
P1 bar    27.5     323.7
P2 bar    151.8    165.4
T1 °C     22.4     42.8
dP 1 bar  124.3    158.3
N 1 U/min 15       2840
Q1 l/min  0.5      321.7

```

```

      using min/max
      for scaling?

      ENT-> confirm

```

11.14 Manual scaling

```

* * PRESENTATION * *
(16-04-98-000)

1-> select measuring
2-> min/max values
3-> scaling
4-> graphic

```

```

* * * * SCALING * * * *
(16-04-98-000)

1-> x-axis
2-> y-axis

```

```

* * * * X-SCALING * * * *
(16-04-98-000)

100      10000
200      20000
500      50000
*1000    alle

      ENT-> confirm

```

This process may take some minutes, depending on the size of the measuring file. The process can be stopped at any time by pressing key „ESC“.

The displayed percentage indicates, how many data has already been processed (in the example: 65 %).

If all min./max. values are determined, they will be displayed immediately. A maximum of six different physical variables can be displayed as min-/max. values.

The example shows the six physical variables of series no. 16-04-98-005 as min-/max. values.

After confirmation with key „ENT“ the instrument's software asks, if the calculated min./max. values should be taken on for scaling.

Press „ENT“ again to confirm.

The automatic scaling is activated.

If your request manual scaling, please press key „3“.

The x-axis as well as the y-axis can be scaled.

If you enter „1“, the x-axis can only be defined in certain degrees. Displaying all measuring points is recommended for small data files only. As an example „1000“ was chosen as a parameter, what means that 1000 sets of measuring values can be displayed at the same time.

When the scanning rate is for example 1ms, this means a display of 1 second.

Here, the selection is carried out with the cursor-keys.

* * * * Y-SCALING * * * *		
(16-04-98-000)		
P1 bar	27.5	323.7
P2 bar	151.8	165.4
T1 °C	22.4	42.8
dP 1 bar	124.3	158.3
N 1 U/min	15	2840
Q1 l/min	0.5	321.7

11.15 Display of graphics

* * * PRESENTATION * * *	
(16-04-98-005)	
1->	select measuring
2->	min/max values
3->	scaling
4->	graphic

When defining the scaling for the y-axis, number values can be entered directly. You can either overwrite the given values or take over the min./max. values, calculated by the instrument, with key „ENT“.

Starting from menu „Display“, the graphic can be displayed as a course of a curve. A condition for that is the activation of the selected data file, here: 16-04-98-005.

11.16 Selection of measurable variables for graphic display

* * * PRESENTATION * * *		
*1 ->	P1	6 -> Q1
2 ->	P2	7 -> dP
3 ->	T1	8 -> ---
4 ->	--	9 -> --
5 ->	N1	
ENT -> confirm		

With key „4“ the following menu is displayed:

To ensure the readability of the display, only variable P1 was selected for the example.

Of course, if other variables are stored, they can be displayed, too. You only have to enter them into the menu „Display selection“.

11.17 Display of a course of the curve

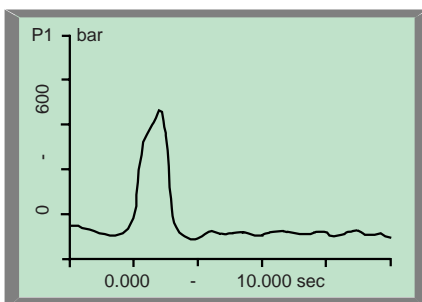

After pressing „ENT“ the graphic is displayed according to the definition of the x-axis (in the example: 1000 sets of measuring values).

If only a part of the graphic is displayed, the whole display can be shifted with the cursor keys.

At the bottom of the display the respective direction is indicated by the arrows << or >>.

If no arrows are displayed, the display does not need to be shifted, as the complete data file can be displayed.

11.18 Deleting measuring value memory

* * * * DELETE * * * * *	
* * MEASUR.-MEMORY * *	
1->	all
2->	single

When deleting the measuring value memory, that means the stored data files, you can choose between deleting single data files or all stored data files by entering the corresponding number:

- 1 = all data files
- 2 = single data files

11.19 Deleting the min./max. memory

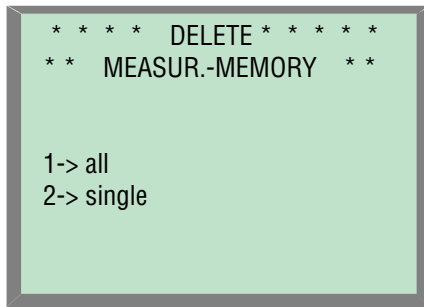

Starting from the menu „Delete min-/max. memory“ you have the possibility to delete single or all measuring value memories.

12. Menu "Printer"

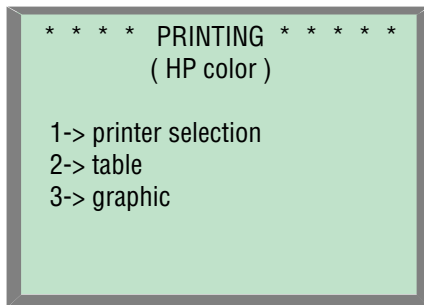

As the connected printer needs to be adapted to the measuring instrument, you have to fix the correct printer type before a printing.

With key  the basic menu and with number „1“ the menu „Select printer“ is invoked. This menu looks as follows:

12.1 Printer selection

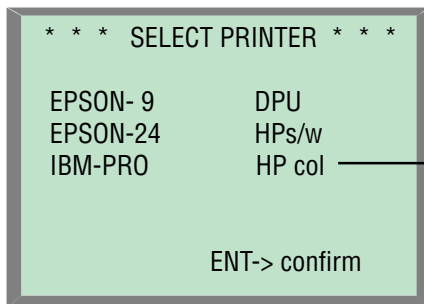

The following printer drivers are supported:

1. Epson 9-pin printer
2. Epson 24-pin printer
3. IBM-proprinter
4. DPU 411
5. HP-Deskjet b/w
6. Deskjet color

Select the requested printer with the cursor-keys and confirm your selection by pressing key „ENT“.

When selecting a Hewlett-Packard printer, please pay attention to the following peculiarity:

When selecting the printer, you already have to indicate, whether the printout shall be black/white or in colour, due to the variety of HP-printers of series Deskjet.

Afterwards, the special HP-printer model needs to be selected.

As an example, the printer HP-colour was chosen, so several types of HPcolour printers are displayed automatically. As can be seen from the star symbol, type 320/340 was chosen with the cursor keys and confirmed with key „ENT“.

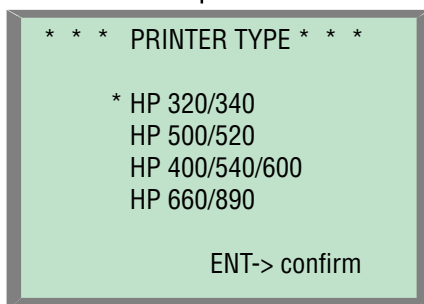

This display will be activated only, if HP-printers were chosen.

12.2 Printout of labels

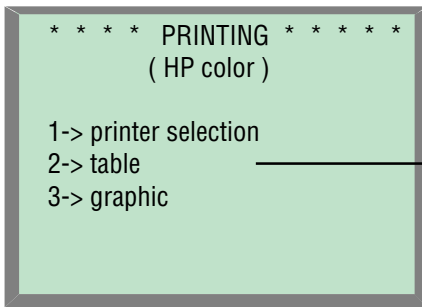

Starting from menu "Printing", press „2“ to start the printout of tables.

12.3 Selecting data files

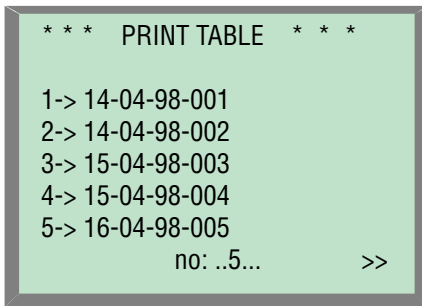



Then you have to select the requested data file.

Either the whole data file or a corresponding part of it can be printed as a table.

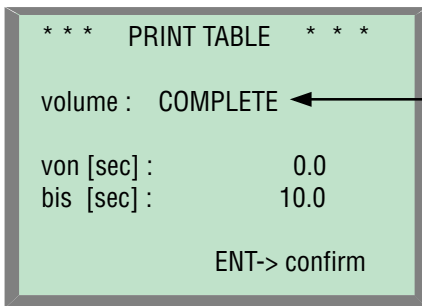
12.4 Fixing the range of a data file



CUT-OUT

With the cursor keys  and  you can choose between „complete“ or „cut-out“. If „cut-out“ is chosen, the period of time to be printed must be defined additionally.

12.5 Selecting measurable variables to be printed

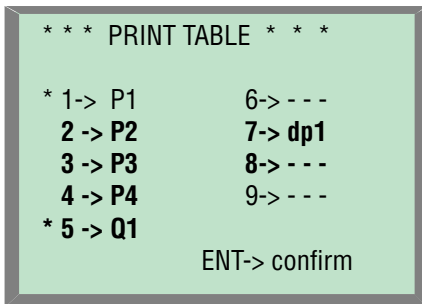

In another step you can define if all stored variables should be printed as a table or only those of special interest.

You can see by the star symbols, that P1 and Q1 were chosen as an example.

To confirm press „ENT“.

12.6 Display while printing tables

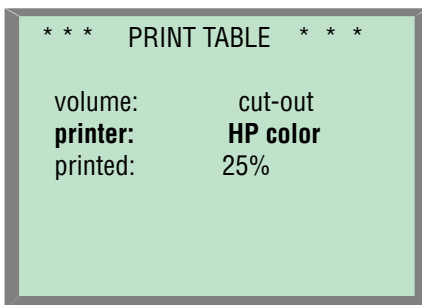

During the printing process the percentage of completion is permanently displayed. When 100% appears on the display, the printing process is completed.

If an error occurs during the printing, the message:

ERROR PRINTER

will be displayed.

After the reason for the error (e.g. by providing paper) was removed, the printing process can be continued by pressing key „ENT“. Otherwise the process is stopped.

12.7 Printing graphics

```
* * * * PRINTING * * * * *
      ( HP color )

1-> printer selection
2-> table
3-> graphic
```

Starting from menu „printing“, press „3“ to invoke the printing of graphics.

12.8 Selecting data files

```
* * * PRINT GRAPHIC * * *

1-> 14-04-98-001
2-> 14-04-98-002
3-> 15-04-98-003
4-> 15-04-98-004
5-> 16-04-98-005
      no: ..5... >>
```

Starting from menu „printing“, press „3“ to invoke the printing of graphics.

12.9 Fixing the range of a data file

```
* * * PRINT GRAPHIC * * *

volume : COMPLETE ← CUT-OUT

from [sec] :      0.0
to  [sec] :      10.0

      ENT-> confirm
```

CUT-OUT

With the cursor keys  and  you can choose between „complete“ or „cut-out“.

If „cut-out“ is chosen, the period of time to be printed must be defined additionally.
Press „ENT“ to confirm.

12.10 Fixing the scaling

```
* * * Y-SCALING * * *

variable      MIN      MAX
P1 bar        10.0     350
Q1 l/min      4.0      210

      ENT-> confirm
```

After this, the Y-axis needs to be scaled, what is done by entering the corresponding min./max. values one after another.
Shall a graphic be printed over the full width of a page, it is recommended to enter real min./max. values.

The input must be confirmed with key „ENT“.

12.11 Fixing graphic markings

```
* * * MARKING * * *

1 -> P1      black
2 -> Q1      green

      ENT-> confirm
```

The next step is displayed automatically.

If several variables shall be printed within a single graphic, we recommend to mark each of them.
When printing black and white, symbols, e.g. cross, triangle, circle, star, square, or rhombus, should be used to mark the variables.
For colour printers there are several colours at the user's disposal: black, blue, green, chinoline blue, red, magenta and yellow.

Select markings and confirm by pressing „ENT“.

12.12 Selecting measurable variables to be printed

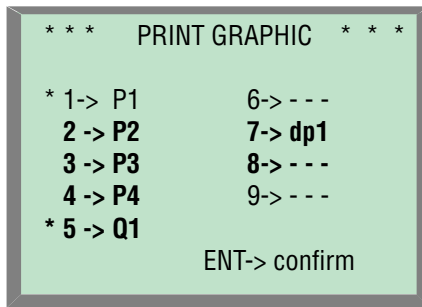

In another step you can define if all stored variables should be printed as a graphic or only those of special interest. You can see by the star symbols, that P1 and Q1 were chosen as an example. To confirm press „ENT“.

12.13 Display while printing graphics

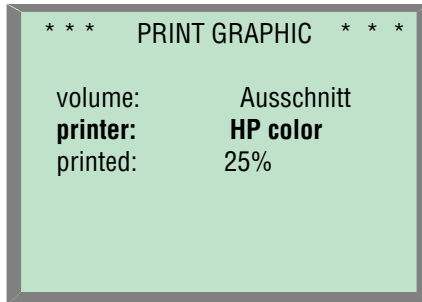

During the printing process the percentage of completion is permanently displayed. When 100% appears on the display, the printing process is completed.

If an error occurs during the printing, the message:

ERROR PRINTER

will be displayed.

After the reason for the error (e.g. by providing paper) was removed, the printing process can be continued by pressing key „ENT“. Otherwise the process is stopped.

13. Re-initialisation of Multi-System 5000

Extreme electromagnetic disturbances may cause digital storage systems to falsify data (which is above the values of the EN 50081 and EN 50082).

That may be the case if stored data occurs to the user as being unrealistic. In such cases the instrument can be re-initialised. Then all values are set to a level pre-defined by HYDROTECHNIK.

The re-initialisation is started by switching the instrument-on and entering the numbers 1, 2 and 3 (use numeral keys) immediately when the display shown below appears.

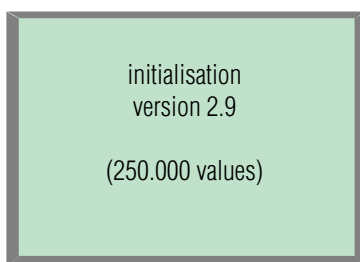

In the next menu you can select among 3 options:

- 0 means: Leaving re-initialisation without any changes
- 1 means: All stored data files are deleted and all parameters are set back to levels pre-set by HYDROTECHNIK
- 2 means: All stored data files are maintained but all parameters are set back to levels pre-set by HYDROTECHNIK

13.1 Selection initialisation

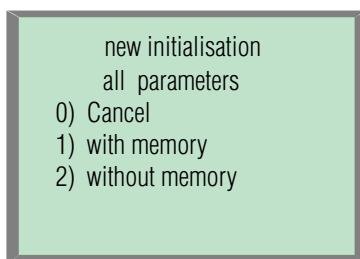

```

MULTI-SYSTEM 5000
Standard 5000
HTBOOT V1.63
EPROM: 31.03.98
RAM: 512 kByte
Time: 00:09
Date: 31/03/98
    
```

If there is no selection after 5 seconds, there will be a display showing specific data of your Multi-System 5000, e.g. the version and the contents of software.

Press „ENT“ to get back to measuring display.

```

new initialisation
all parameters
0) Cancel
1) with memory
2) without memory
    
```

When selecting 1) or 2) the menus for defining user language and date/time will be displayed.

```

* * * SYSTEM PROG * * *
SPRACHE
deutsch
* English
français
ENT-> confirm
    
```

First the language must be determined.

Then date and time must be adjusted again.

```

* * * SYSTEM PROG * * *
clock
date: 06/05/98
time: 10 : 55
    
```

After that you have to enter all parameters again with keys Prog.

and measure
Messen .

The following basic adjustments are valid after a re-initialisation:

- calibration values:** all values are deleted or set to zero
- sensor:** 0 to 20 mA
- selection of display:** p1-p4, dp1, dp2, Q1 and N1 (all of them activated)
- definition of display:** set to measuring values
- definition of calculation:** W1 and W2 (dp1 and dp2) active
- printer:** Epson 9-pin
- storage parameters:**
variable p1, scanning rate 10 ms, storage time 5s, trigger mode „key“,
trigger variable at „start“, trigger operator „none“, value „none“
and pretrigger 50%
- contrast:** mean value
- measuring units:** SI units (bar, l/min and RPM.)
- orifice gauge:** type A3

14. Pin connections of the measuring instrument Multi-System 5000

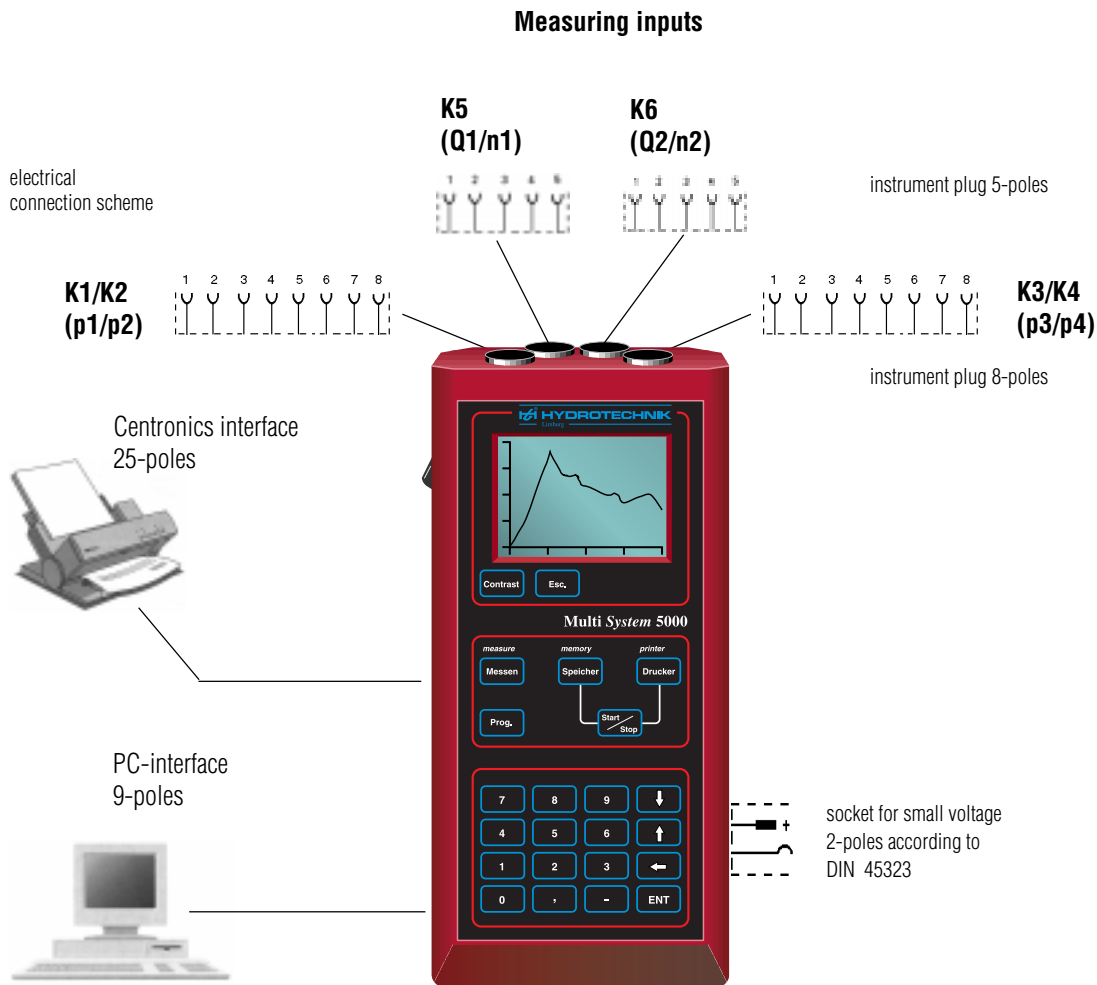

Measuring input K1/K2/K3/K4

Pinconnection	Analogue signal input	
	0 - 20 mA 3-wire	4 - 20 mA 2-wire
1	+Ub (K1/K3) *14,4 VDC (external 24 VDC)	+Ub (K1/K3) *14,4 VDC (external 24 VDC)
2	signal+ (K1/K3) (R _L 100 Ohm)	signal+ (K1/K3) (R _L 100 Ohm)
3	Mass (K1/K3)	
4	+Ub (K 2/K4) *14,4 VDC (external 24 VDC)	+Ub (K 2/K4) *14,4 VDC (external 24 VDC)
5	signal + (K2/K4) (R _L 100 Ohm)	signal+ (K2/K4) (R _L 100 Ohm)
6	Mass (K2/K4)	
7	Cable screen	
8	Cable screen	

Measuring input K5 or K6

Pinconnection	Frequency input
1	Signal + (automatic switching over between 2 - 300 mV and 5 - 10 V)
2	Mass f. signal- and U _{b-}
3	int. battery voltage *14,4 VDC I _{out} max. 50 mA
4	no connection N/C
5	Cable screen

15. Technical information for the connection of pressure sensors, 0 to 20 mA and 4 to 20 mA type

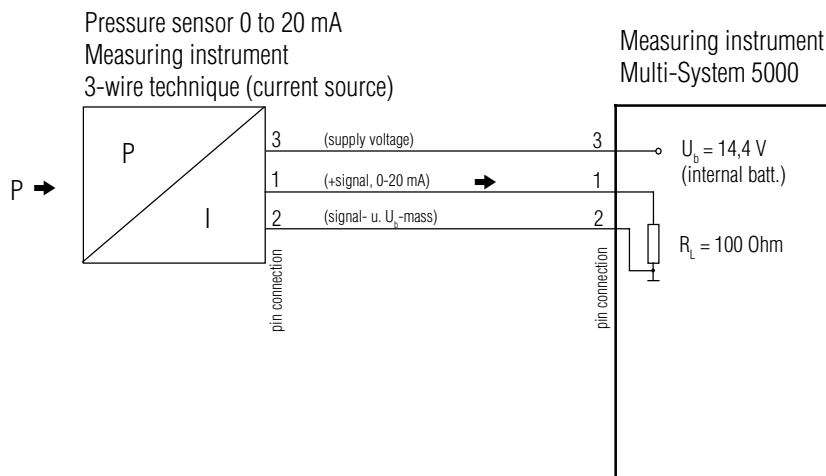
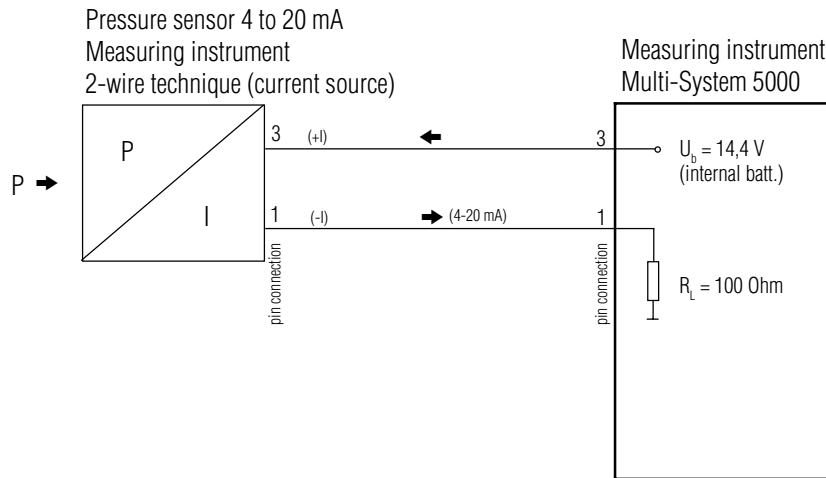

Please pay attention when connecting sensors from other manufacturers:

* When connecting an external voltage supply e.g. through net adaptor from HYDROTECHNIK, the supply voltage for the sensors is equal to the net adaptor voltage of 24 VDC (- approx. 1,5 V). In cases, where a free external voltage for the measuring instrument is chosen, the voltage supply for the sensors can be between 24 V and 30 VDC (- approx. 1,5 V).

16. Processing times (internal calculation time) of the Multi-System 5000

Function	Version 2.5 (approx. 120 000 measuring values)	Version 2.5 (approx. 2500 000 measuring values)
Black/white printout HP 340 Colour printout with HP 340	5:25 min 6:07 min	6:40 min 7:15 min
Calculation of min/max. value	1:17 min	1:35 min
Graphic display	1:22 min	1:40 min
Data transfer (38400 Baud)	5 min	10 min

The indicated times refer to one series of measurements, i.e. for p1., when using the completely available memory.

17. Pin connection of the HYDROTECHNIK-Sensors

Pressure sensor PR 15

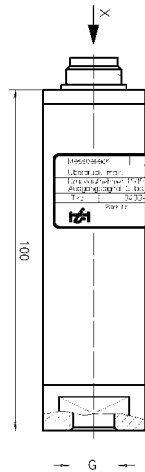

Connection scheme

3-wire technique 0 to 20 mA (PR 15 and HD)

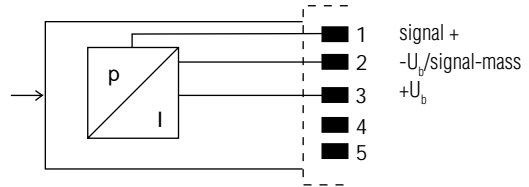

2-wire technique 4 to 20 mA (PR 15 and HD)

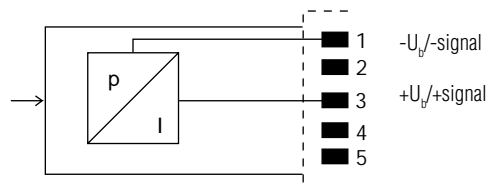

Pressure sensor HD

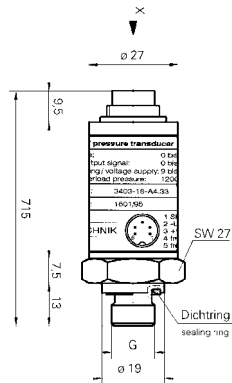

Necessary measuring cable:

Separating cable TK 07 : Part-no. 8824-A1-00.20

Measuring cable MK 01 : Part-no. 8824-91-02.50

Dual sensor p/T for pressure and temperature (screw-in sensor)

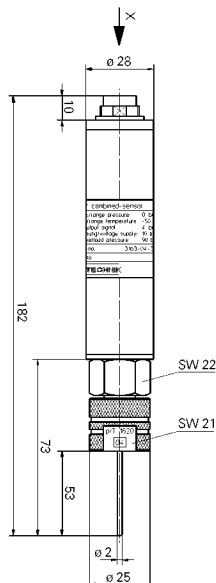

2-wire technique 4 to 20 mA (two independent, separate power sources)

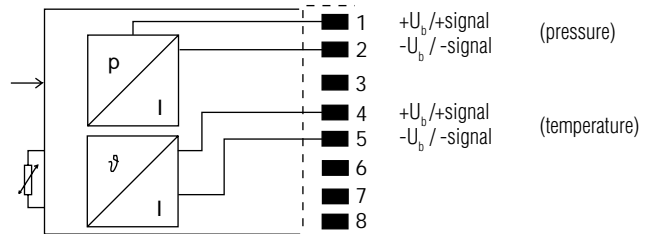

Necessary measuring cable:

MK 14: Part.-no. 8824-A8-02.50,
directly connection to the measuring input
K1/K2 oder K3/K4

**Temperature sensor
(screw-in sensor)**

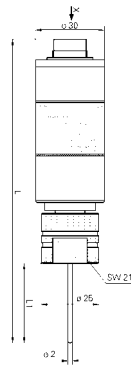

3-wire technique 0 to 20 mA

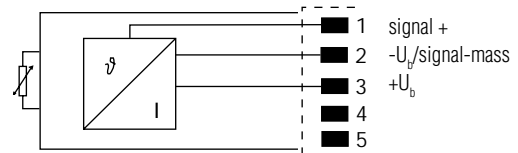

2-wire technique 4 to 20 mA

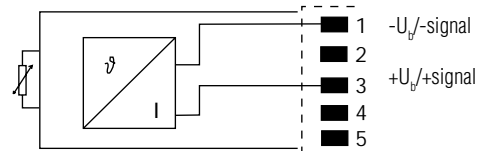

Necessary measuring cable:
 Divider cable TK 07 : Part-no. 8824-A1-00.20
 Measuring cable MK 01 : Part-no. 8824-91-02.50

Rev. speed probe DS 03

connection scheme

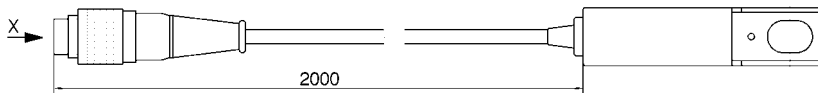

Output: square wave signal



If required, extension through measuring cable
 MK 01: part-no. 8824-91-02.50

Turbine RE 3



Inductive transducer with amplifier
Output: square wave signal

Turbine RE 4

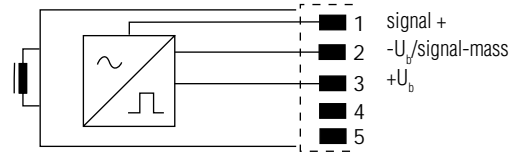

When using an inductive transducer without amplifier, pin 3 is not connected, pin 1 and pin 2 are without indication of polarity

necessary measuring cable:
MK 01: part-no. 8824-91-02.50

Gear flow meters type GFM



Magnetoresistor sensor with amplifier
Output: square wave signal

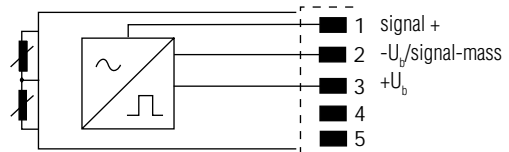

necessary measuring cable:
MK 01: part-no. 8824-91-02.50

Measuring cable MK 01 with pin connections, standard length 2,5 m

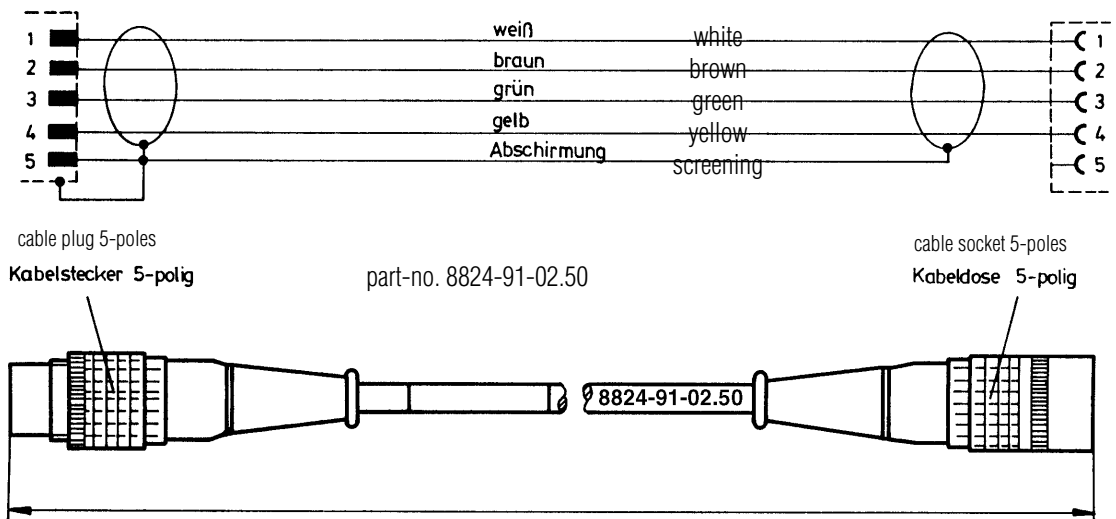

18. Measuring cable with pin connections

Measuring cable MK 14,

with pin connection, for direct connection of the dual sensor for pressure and temperature und Temperatur (separating cable not necessary!) standard length 2,5 m

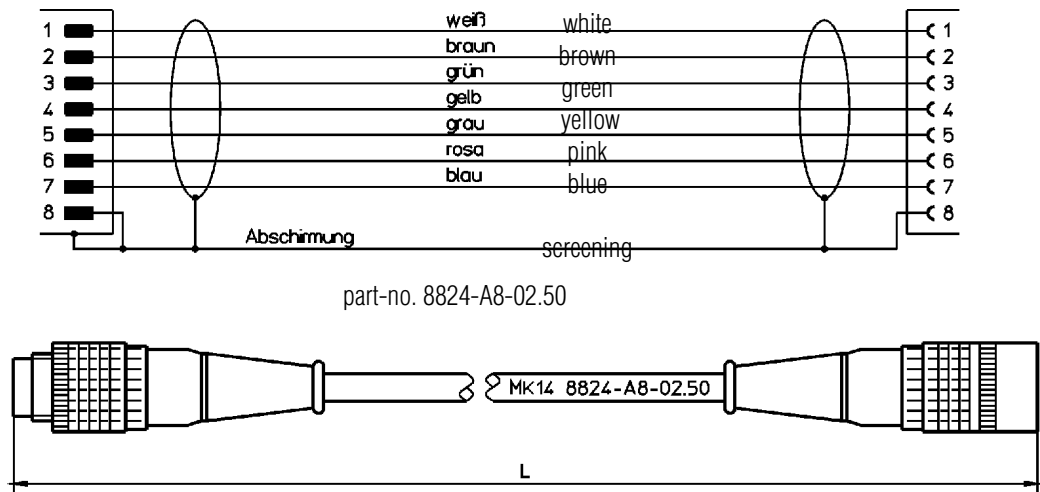

Separating cable TK 07,

with pin connections. This cable is always necessary for the connection of the sensors to the analogue measuring input K2/K4 or K1/K3. By this, two sensors can be connected to one measuring input. Standard length: 20 cm.

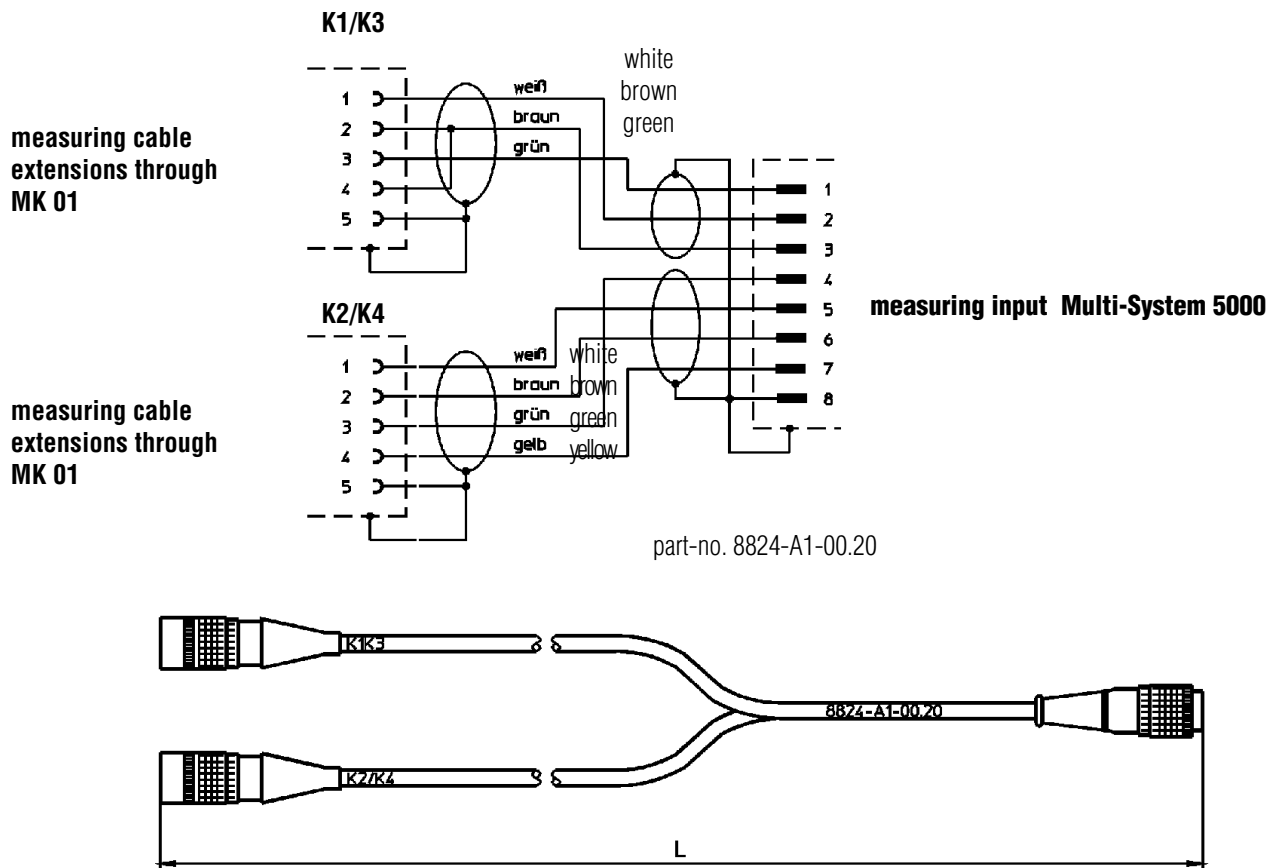

19. Error detection

The Multi-System 5000 has been tested and adjusted at the manufacturer according to the most stringent quality standard. Should you have any problems nevertheless, please check the instrument, according to the following list, first.

Disturbance/wrong operation	Checks/remedy
After the switching-on of the instrument the display shows nothing.	<ul style="list-style-type: none"> • The battery is empty, please recharge the internal batteries of the instrument with net adapter 230 VAC/secondary 24 VDC for approx. 14 to 16 hours.
No display or a very weak display appears	<ul style="list-style-type: none"> • Keep key „Contrast“ pressed until the display is shown clearly
The measuring value display shows only horizontal lines	<ul style="list-style-type: none"> • At 4 to 20 mA sensors it can happen, that the sensor itself, or the measuring cable is not connected or defective.
Wrong measurement of pressure or temperature (unlikely measuring values).	<ul style="list-style-type: none"> • The current signal of the sensor isn't adjusted correctly to 0 to 20 mA or to 4 to 20 mA. Readjust it if necessary.
Wrong measurement of pressure differential (unlikely Δ -p measuring value).	<ul style="list-style-type: none"> • The pressure differential alignment is wrong, please carry out the alignment according to the description on page 29.
Wrong pressure peak values.	<ul style="list-style-type: none"> • Old min/max. values are still stored in the memory. Before measuring pressure peaks, you always have to delete the content of the memory, see page 43.
"Function blocked"	<ul style="list-style-type: none"> • Please press the key "measure" and then select "2-> def. calculation" and select W1 or W2 or W3, now you will be able to change the blocked function by selecting position "none".
The display shows „Over“.	<ul style="list-style-type: none"> • The input measuring range has been exceeded. There is either a short circuit in the sensor or the cable or the pressure measuring cell was mechanically overloaded (overpressurized).
The display shows „Charge battery“.	<ul style="list-style-type: none"> • The batteries of the measuring instrument can be recharged with a HYDROTECHNIK net adapter (230 VAC, secondary 24 VDC) or with an external voltage among 24 V and max. 30 V (stabilised) via the external voltage socket. We recommend a charging time of 14 to 16 hours.

20. Technical data for Multi-System 5000

(reference of the specified data 20 °C ±3 °C)

Measuring inputs:	4 input sockets (Amphenol-Tuchel) 2 x 8-poles, signal inputs K1 to K4: 0 to 20 mA, reversible in 4 to 20 mA by internal software 2 x 5-poles digital inputs (frequencies): automatic sensitivity switching: 1 to 5000 Hz (insensible 5 to 10 V) 50 to 5000 Hz (sensible 2 to 300 mV)
Standard measurable variables:	Pressure, pressure peaks, volume flow rate, rev. speed, direct current, direct voltage, force, moment of force, displacement and speed can be freely selected with 5-digit display and floating decimal point. Rev. speed: from 60 min ⁻¹ on, display 5-digits (referring to one scanning marking)
Measuring rate:	Analogue inputs: 1 ms Digital inputs (pulses): Between 1 Hz and 60 Hz a single measurement of the period duration is made. From 60 Hz on, the measuring time is constant with 16 ms.
Resolution A/D-converter:	12 bit
Extreme value memory:	Min. and max. value storage of all measuring channels in the background. Display by keystroke.
Measuring value memory:	Max. 120.000 measuring values (depending on the selected measurable variable) with scanning rate from 1 ms to 9 min. that can be selected.
Data protection:	Battery-buffered RAM-memory for data protection.
Display:	8-lines LCD, height of the figures: 4,24 mm, measuring value display up to max. 8 lines
Interfaces:	Centronics for printer RS 232 for PC-connection
CE-Kennzeichnung:	Fulfills EN 50 081-1 and EN 50 082-1
Power supply:	Internal 14,4 V NiCd-battery, 0,7 Ah for approx. 5 hours continuous operation with integrated charging device and battery status display. External voltage supply with plug-in power supply unit 230 VAC, secondary 24 VDC, or through external voltage supply unit (stabilised 24 V to 30 VDC).
Ambient conditions:	Working temperature: 0 °C to +50 °C, Relative humidity: <80%
General information:	Housing material: ABS-plastic Dimensions: 252 x 121 x 50 mm (L x W x H) Weight: 0,95 kg

Technical modifications are subject to change without notice.

21. Information on guarantee

Within the framework of our guarantee conditions we guarantee the unobjectionable manufacture of our technical instruments.

The guarantee is valid for 6 months.

In principle, the general terms of business are valid.

The right to claim under guarantee becomes invalid, when repairs or interventions are executed by persons, who were not authorised by us.

Within the six months of the guarantee, we will remove free of charge damages or defects, which can be proved to be based on a works mistake, as far as the customer informs us immediately after having detected it, but within six months at the latest.

The fulfilling of the guarantee is done in a way, that defective parts are repaired or replaced by unobjectionable parts at our choice, free of charge.

Instruments, for which you want to claim under guarantee, have to be sent carriage paid together with the corresponding copy of the invoice or the delivery note to:

HYDROTECHNIK - Service

22. Maintenance

Your measuring instrument is a precision instrument, which will work without trouble for many years, if it is treated correspondingly.

However, in the case that interferences occur nevertheless, please do not try to repair the instrument yourself!

Leave the maintenance or the repair up to our HYDROTECHNIK-SERVICE.

HYDROTECHNIK - Service

Address: HYDROTECHNIK GmbH
Holzheimer Straße 94 - 96
D-65549 Limburg
Tel.: 0 64 31 - 40 04 · 0
Fax 0 64 31 - 4 53 08
Internet: <http://www.hydrotechnik.com>
e-Mail: info@hydrotechnik.com

Should your Multi-System 5000 require repair, we depend on your support. Please describe your complaint as precisely as possible. That enable us to locate the error more easily and you will profit from shorter repair times.

If we have any additional queries, please state the person to contact:

Company:	
Department:	
Name:	
Telephone:	
Fax:	

Please tick the appropriate answer:

Part to repaired: Measuring instr. Sensor Cable Supply unit	Your PC 386 486 Pentium P 2	operating system DOS Windows 3.1x or Windows 95 NT	software HYDROcomsys/DOS: version HYDROcomsys/Windows: version
--	--	---	---

How to describe an error:

Please leave all parameters etc. unchanged after an error occurs. Briefly describe your measuring task, connection of sensor, parameter adjustments (for example memory parameters, trigger, how many measuring values are acquired, type of printer, etc.

Your description:

Order data for the Multi-System 5000

						Part-number
- Handheld measuring instrument Multi-System 5000 Adapter 230 VAC / 24 VDC / 340 mA Adapter 115 VAC / 24 VDC Alternating battery 14,4 VDC / 700 mAh						3160-00-53.00 8812-00-00.19 8812-00-00.20 8873-02-00.02
Sensors						
- Pressure (output signal: 0 to 20 mA) Pressure sensor type PR 15	Measuring range in bar (psi)	-1	to	+6	(-14,5... 87)	3403-32-71.33
		0	to	60	(... 870)	3403-21-71.33
		0	to	200	(... 2900)	3403-10-71.33
		0	to	400	(... 5800)	3403-15-71.33
		0	to	600	(... 8700)	3403-18-71.33
		0	to	1000	(... 145000)	3403-29-71.33
- Pressure (output signal: 4 to 20 mA) Pressure sensor type PR 15	Measuring range in bar (psi)	-1	to	+6	(-14,5... 87)	3403-32-71.37
		0	to	60	(... 870)	3403-21-71.37
		0	to	200	(... 2900)	3403-10-71.37
		0	to	400	(... 5800)	3403-15-71.37
		0	to	600	(... 8700)	3403-18-71.37
		0	to	1000	(... 145000)	3403-29-71.37
- Volume flow rate Measuring turbine RE 3 Sinusoidal signal 1,5 to 150 mV _{pp} with MINIMESS and p/T-coupling (series 1620) (Please see our brochure "Measuring turbines RE 3 / RE 4" for further technical details)	Measuring range in l/min (gal / min)	7,5	to	75	(2... 20,0)	3107-21-35.00
		15,0	to	300	(4... 79,0)	3107-30-35.00
		25,0	to	600	(6,6... 158,5)	3107-40-35.00
- Volume flow rate Measuring turbine RE 4 Sinusoidal signal 1,5 to 150 mV _{pp} with MINIMESS and p/T-coupling (series 1620) (Please see our brochure "Measuring turbines RE 3 / RE 4" for further technical details)	Measuring range in l/min (gal / min)	1,0	to	10	(0,26... 2,6)	3107-01-35.00
		7,5	to	75	(2... 20,0)	3107-70-35.00
		15,0	to	300	(4... 79,0)	3107-71-35.00
		25,0	to	600	(6,6... 158,5)	3107-72-35.00
- Volume flow rate Gear flow meter type GFM Output signal (square wave) with MINIMESS and p/T-coupling (series 1620) (Please see our brochure "Gear flow meter GFM" for further technical details)	Measuring range in l/min (gal / min)	0,005	to	1	(0,0013... 0,25)	3143-01-35.00
		0,05	to	5	(0,013... 1,3)	3143-02-35.00
		0,2	to	30	(0,05... 8)	3143-03-35.00
		0,7	to	70	(0,18... 18,5)	3143-04-35.00
- Volume flow rate Orifice gauge with MINIMESS screw coupling series 1620 Acquisition of the volume flow rate through measurement of the pressure differential with two pressure sensors and evaluation software in the Multi-System 5000 (Please see our data sheet "Orifice gauge" for further technical details)	Measuring range in l/min (gal / min)	10	to	50	(2,64... 13,21)	3125-03-03.00
		40	to	210	(10,57... 55,48)	3125-03-06.00
		120	to	600	(31,70... 158,50)	3125-03-09.00
- Temperature (screw-in sensor) 3-wire technique with output signal 0 to 20 mA, for p/T-coupling 1620 (ident.-no. 04) - Temperature (screw-in sensor) 2-wire technique with output signal 4 to 20 mA, for p/T-coupling 1620 (ident.-no. 04) - Surface sensor (Pt 100, 2-wire technique) with output signal 4 to 20 mA, helix cable connection (approx. 1,2 m stretched) - Immersion sensor (Pt 100, 2-wire technique) with output signal 4 to 20 mA, helix cable connection (approx. 1,2 m stretched)	Measuring range in °C (°F)	-50	to	+200		3973-04-01.00
		(-58	to	+392)		3969-04-01.00
						3170-01-03.00
						3170-02-06.00
- Rev. speed , (infrared-sensor type DS 03) with 25 pieces of reflective foil - Inductive transducer (measurement of rev. speed on gear wheels) - Reflective foil (spare parts, 50 pieces)	Measuring range in min ⁻¹ (rpm)	1	to	9999		3130-02-01.00
						3107-00-06.00
						8840-02-01.01

Accessories	Part-number
<ul style="list-style-type: none"> - Measuring cable MK 01 (length 2,5 m) for the connection to pressure-, rev. speed-, temperature- and volume flow rate sensors - Measuring cable MK 14 (length 2,5 m) for the connection to p/T-dual sensor - Divider cable TK 07 (length 20 cm) always necessary for the analog inputs, max. 2 pcs. - Connection cable (length 5 m) for external batteries 	<p>8824-91-02.50 8824-A8-02.50 8824-A1-00.20 8824-64-05.00</p>
<ul style="list-style-type: none"> - Transport case (plastic box) - Transport case I - Transport case II (with additional cover and space for printer) 	<p>3160-00-16.01 3160-00-17.01 3160-00-18.07</p>
<ul style="list-style-type: none"> - Leather shoulder strap for Multi-System 5000 - Artificial leather bag for protection of the Multi-System 5000 	<p>8875-03-00.01 8875-01-01.00</p>
<ul style="list-style-type: none"> - Ink jet printer (black/white) battery operation with adapter (100 to 240 VAC / 50/60 Hz) - Colour extension - Spare part ink cartridge in black - Spare part ink cartridge in colour - Data communication cable Centronics 36-poles / 25-poles 	<p>8865-01-09.00 8865-01-10.11 8865-01-09.01 8865-01-10.01 8824-36-02.00</p>
<ul style="list-style-type: none"> - Direct connection for pressure sensor type PR 15 - straight (series 1620 - M 16x2) - Direct connection for pressure sensor type PR 15 - 90° (series 1620 - M 16x2) - p/T-measuring coupling 1620 (ident. no. 04) screw-in thread M 10x1 - p/T-measuring coupling 1620 (ident. no. 04) screw-in thread ISO 228-G 1/4 	<p>2146-05-30.00 2146-54-19.40 2149-04-19.13 2149-04-15.13</p>
<p>additional measurement of direct voltage or direct current possible</p> <ul style="list-style-type: none"> - Voltage (external connection adapter) with signal output 0 to 20 mA - Current (external connection adapter) with signal output 0 to 20 mA 	<p>Measuring range 0 to ± 48 V $\overline{\text{---}}$ Measuring range 0 to ± 2 A $\overline{\text{---}}$</p> <p>3160-00-00.22 3160-00-00.23</p>
<ul style="list-style-type: none"> - Software support for Multi-System 5000 for the display and evaluation of measuring values on PC- XT/AT/PS/2 HYDROcomsys/DOS-software package from DOS 4.0 on - HYDROcomsys/Win-software package (Windows-Version) with two licenses - Data communication cable for RS 232 	<p>diskette 3 1/2" German diskette 3 1/2" English</p> <p>8874-01-01.02 8874-01-01.05</p> <p>diskette 3 1/2" German diskette 3 1/2" English</p> <p>8874-01-01.21 8874-01-01.23</p> <p>9-poles / 9-poles 9-poles / 25-poles</p> <p>8824-43-02.00 8824-44-02.00</p>