

MultiSystem 8050 MultiControl 8050 MultiPanel 8050

Multi-functional Data Logger



Operating Instructions Manual

Rev. 2.5 EN • March 21, 2012

Firmware Version 3.3
TKZ L3160-00-65.00EN

Contents

1	Safety	4
1.1	General safety and warning hints	4
1.2	Hints for the use of the MultiSystem	4
1.3	Hints for the use of sensors and cables	5
1.4	Hints for the connection of printers	5
1.5	Hints for the use of the touchpanel	5
2	Introduction	6
2.1	Range of validity	6
2.2	Copyright	6
2.3	Limitation of liability	6
2.4	Use as agreed	7
2.5	Warranty regulations	7
2.6	Obligations of the customer	7
2.7	Authorized staff	7
3	Description of the measuring instrument	8
3.1	Qualities of the MultiSystem 8050	8
3.2	Components of the instrument	8
3.3	Connectors	11
4	Operation of the measuring instrument	13
4.1	Switch instrument on and off	13
4.2	Elements on the screen	14
4.2.1	<i>Numerical measured value display</i>	15
4.2.2	<i>Graphical measured value display</i>	16
5	Menu operation	17
5.1	Channel menu	18
5.1.1	<i>Configuration of analog inputs (ch1 ... ch10)</i>	19
5.1.2	<i>Configuration of voltage/current inputs (ch11 / ch12)</i>	21
5.1.3	<i>Configuration of the frequency inputs (ch13 ... ch16)</i>	22
5.1.4	<i>Configuration of trigger in- and output (ch17 / ch21)</i>	23
5.1.5	<i>Configuration of digital inputs (ch18 ... ch20)</i>	25
5.1.6	<i>Configuration of digital outputs (ch22 ... ch24)</i>	25
5.1.7	<i>Configuration of analog outputs (ch25 / ch26)</i>	26
5.1.8	<i>Configuration of special channels (ch27 ... ch32)</i>	27
5.2	Display menu	29
5.3	Memory menu	32
5.4	Device menu	34
5.4.1	<i>Set channel filters</i>	35
5.4.2	<i>Hardware setup</i>	36
5.4.3	<i>Logger function</i>	37
5.5	Project menu	38
5.6	HYDRORun menu	39
6	Record and present measured values	42
6.1	Record measured values	42
6.2	Present recorded series of measurement	42
6.2.1	<i>Select series of measurement</i>	44
6.2.2	<i>Assign presentation parameters</i>	45
6.2.3	<i>Present series of measurement</i>	47
7	Automatic test procedures with HYDRORun	54
8	Operation	55
8.1	Start the software	55
8.2	Functional parts of the screen	55
8.3	Connect with a measuring instrument	56
8.4	HYDROLink screen modes	57
8.5	Operations during monitoring measured values	58

8.6	HYDROlink operation menus.....	59
8.6.1	Program menu.....	59
8.6.2	Menus menu.....	59
8.6.3	View menu.....	59
8.6.4	Instruments menu.....	59
8.6.5	Configuration menu.....	59
8.6.6	HYDRORun menu.....	60
9	Technical Data.....	61

Illustrations

Pic. 1	Front view.....	8
Pic. 2	Rear view.....	9
Pic. 3	Right-side connectors.....	9
Pic. 4	Rear side connectors.....	9
Pic. 5	Start screen.....	13
Pic. 6	Measuring display.....	14
Pic. 7	Elements on the screen.....	14
Pic. 8	Display mode „TEXT“.....	15
Pic. 9	Display mode „GRAPHIC“.....	16
Pic. 10	Virtual keyboard.....	17
Pic. 11	Virtual 10-key pad.....	18
Pic. 12	Channel menu.....	18
Pic. 13	Configure analog inputs.....	19
Pic. 14	Zero point alignment.....	20
Pic. 15	Linearisation function.....	20
Pic. 16	Enter linearisation table.....	21
Pic. 17	Configure inputs for voltage/current.....	21
Pic. 18	Configure frequency inputs.....	22
Pic. 19	Configure trigger input.....	23
Pic. 20	Configure trigger output.....	24
Pic. 21	Configure digital inputs.....	25
Pic. 22	Configure digital outputs.....	25
Pic. 23	Configure analog outputs.....	26
Pic. 24	Configure calculated channels.....	27
Pic. 25	Configure CAN channel.....	28
Pic. 26	Display menu.....	29
Pic. 27	Adapt scaling.....	30
Pic. 28	Assign colors and symbols.....	31
Pic. 29	Set contrast.....	32
Pic. 30	Memory menu.....	32
Pic. 31	Define trigger.....	33
Pic. 32	Device menu.....	34
Pic. 33	Set channel filters.....	35
Pic. 34	Hardware setup.....	36
Pic. 35	Compact Flash information.....	37
Pic. 36	Project menu.....	38
Pic. 37	HYDRORun menu.....	39
Pic. 38	Release HYDRORun.....	40
Pic. 39	Delete test procedures.....	41
Pic. 40	Initiate recording.....	42
Pic. 41	Present series of measurement.....	43
Pic. 42	Select measurement data.....	44
Pic. 43	Adapt presentation parameters.....	45
Pic. 44	Adapt scaling.....	46
Pic. 45	Adapt graphic settings.....	47
Pic. 46	Graph $y = f(t)$	48
Pic. 47	Use spot values.....	49
Pic. 48	Use delta spot values.....	50
Pic. 49	Graph $y = f(x)$	51
Pic. 50	Table.....	51
Pic. 51	Select intermediate values.....	52
Pic. 52	Intermediate values.....	52
Pic. 53	Display statistical data.....	53
Pic. 54	Starting a test procedure.....	54



Validity for various versions

The explanations contained in this document are valid for all versions of the measuring system 8050. The version MultiControl and MultiPanel are operated with a PC using the software **HYDROlink**. The operation structure is identical compared to the MultiSystem 8050, but the shown screenshots differ optically.

1 Safety

1.1 General safety and warning hints



ATTENTION – Dangerous electrical current

- Never cut, damage or modify the power cord of the power pack and place anything on it.
- Never touch the power pack with wet or humid hands.
- Connect the power pack to suitable power sources, only. See technical data.
- Unplug the power cord during thunderstorms.
- Unplug the power cord if you detect unusual smell or if you see smoke, or if the cable is damaged.
- Ground the installation appropriately. There may be wrong measurements in case of faulty grounding.

1.2 Hints for the use of the MultiSystem



Treat the measuring instrument carefully

- Never expose the device to excessive heat or humidity. Obtain the technical data.
- Do not store the device at humid and dusty locations or at temperatures below zero.
- Never dip the device into water or other liquids. Never let liquids come into the device.
- Never open the device.
- Do not use the device after it fell down or if the casing is damaged.
- Avoid strong magnetic fields. Keep the measuring instrument away from electric motors and other devices that produce electro-magnetic fields. Strong magnetic fields may cause malfunctions and influence measuring results.
- Avoid the condensing of water. If water has condensed, the device must acclimate before you may switch it on. Otherwise it could be damaged.

1.3 Hints for the use of sensors and cables



Sensors and cables can be damaged

- Protect the sensors from the exceeding of the allowed power supply range, mechanical overload and wrong pin assignment.
- When using sensors without ISDS (Intelligent Sensor Detection System), you have to enter the sensor parameters error-free into the instrument.
- The measuring cables MK01 and MKS may not be lengthened, otherwise the shielding will be interrupted.
- The data of an ISDS sensor will be read into the instrument after it is switched on. When you connect new sensors, the instrument must be switched off and on to write the sensor data into the device memory.

1.4 Hints for the connection of printers



Not all printers are supported

The measuring instrument supports printers with centronics interface, only. Due to the large variety it is not possible to support all printers in the market. This is why Hydrotechnik only assures the complete support of those printers contained in the printer selection list of the instrument. Please contact our customer support for questions, whether your printer is supported.

1.5 Hints for the use of the touchpanel



Treat the touchpanel carefully

The measuring instrument is equipped with a touch-sensitive monitor. By touching certain parts of the display, you can give commands of activate settings.

- Touch the monitor gently! Let your finger rest a moment on the surface to trigger the desired function.
- Never knock on the monitor with impetus or force. This will damage the surface!
- Keep the monitor clean. Never use aggressive or strong detergents or solvents. Normally, a slightly dampened soft cloth is sufficient for the cleaning, persistent dirt can be removed using a mild household detergent.

2 Introduction



Do not loose claims

The information and hints in this section are important. By ignoring them you may loose claims from guarantee and warranty.

2.1 Range of validity

The manual on hand is valid for measuring instruments named "MultiSystem 8050". It addresses to the operator of this instrument, that means the person, who works with the instrument.

The manual is not a technical manual. Please contact our service staff for questions, that exceed the contents of this manual.

2.2 Copyright

The measuring instrument and this manual are protected on copyright. Manufacture without license will be prosecuted by law. All rights reserved on this manual, even the reproduction and/or duplication in any thinkable form, e.g. by photocopying, printing, on any data recording media or translated. Reproduction of this manual is only permitted with a written approval of Hydrotechnik GmbH.

The technical state by the time of delivery of instrument and manual is decisive, if no other information is given. Technical changes without special announcements are reserved. Earlier manuals are no longer valid.

The general conditions of sale and delivery of Hydrotechnik GmbH are valid.

2.3 Limitation of liability

We guarantee the faultless functioning of our product in accordance with our advertising, the product information edited by Hydrotechnik GmbH and this manual. Further product features are not guaranteed. We take no liability for the economy and faultless function if the product is used for a different purpose than that, described in the chapter „Use as agreed“.

Compensation claims are generally impossible, except if intention or culpable negligence by Hydrotechnik GmbH is proved, or if assured product features are not provided. If the product is used in environments, for which it is not suited or which do not represent the technical standard, we are not responsible for the consequences.

We are not responsible for damages at installations and systems in the surroundings of the product, which are caused by a fault of the product or an error in this manual.

We are not responsible for the violation of patents and/or other rights of third persons outside the Federal Republic of Germany.

We are not liable for damages, which result from improper operation according to this manual. We are not liable for missed profit and for consecuting damages due to non regardance of safety advice and warning hints. We don't accept liability for damages which result from the use of accessoires which are not delivered and/or approved by Hydrotechnik GmbH.

The products of Hydrotechnik GmbH are designed for a long life. They represent the standard of technique and science and were checked on all functions individually before delivery. The electrical and mechanical construction corresponds to the current norms and regulations. Hydrotechnik GmbH is doing product and market research for the further development and permanent improvement of their products.

In case of faults and/or technical trouble please contact the Hydrotechnik GmbH service staff. We assure that suitable measures will be taken immediately. Hydrotechnik GmbH guarantee regulations are valid, which we will send to you on demand.

2.4 Use as agreed

The measuring instrument "MultiSystem 8050" is a mobile, hand-held instrument for the recording, storage and evaluation of measurement data, collected by sensors connected to the instrument.

You can connect a large variety of different sensors to the instrument, but they have to meet the requirements defined in the section "Technical data".

Any other use of the measuring instrument is considered as not agreed.

If you have any question or want to use the measuring instrument for a different purpose, please do not hesitate to contact our service staff. We are pleased to help you.

2.5 Warranty regulations

In accordance to our warranty regulations we guarantee the condition without defects for this measuring instrument for a duration of six months. Wearing parts and storage batteries are excepted from this warranty. The warranty is spoiled if repair work or interventions are executed by unauthorized persons.

Within the warranty period we repair damage or defects which are caused by a manufacturing fault. We only accept warranty claims if they are reported to us immediately after their discovery, but latest six months after delivery. The warranty benefit is by our choice through repair of defective parts or replacement by intact parts.

Send your instrument with an invoice copy or delivery note copy to Hydrotechnik. The address is mentioned at the end of this manual.

2.6 Obligations of the customer

The operating authority of this product has to assure, that only persons who

- know the regulations on working safety and accident prevention
- have been instructed in the operation of this product
- have read and understood this manual

can operate this product. Persons who operate this instrument are obliged to

- obey all regulations on working safety and accident prevention
- read this manual completely, especially the safety instructions in the first chapter.

2.7 Authorized staff

Persons are authorized if they have a professional education, technical experience, knowledge of the important norms and regulations and if they are able to estimate their duties and recognize possible danger at an early time.

Operator of the instrument

Persons are authorized if they are trained in the operation of the instrument and have read and understood this manual completely.

Personell for installation and maintenance

Persons are authorized if they are trained in all aspects of the instrument and have read and understood this manual completely.

3 Description of the measuring instrument

3.1 Qualities of the MultiSystem 8050

The MultiSystem 8050 is a practice oriented, user-friendly measuring system that supports the user in his daily measuring tasks efficiently. When using ISDS sensors, the MultiSystem automatically detects the connected sensors during the start-up and reads in all parameters: measuring range, physical measurand, units, output signal and characteristic curve (linearisation). A mix up of the sensor and the manual entry of the sensor data are things of the past. But you are always free to connect sensors without ISDS signal to the instrument. Then you can use clearly arranged operation menus for the input of the parameters.

The saved measuring data can be transferred fast and easy to a PC by using the USB interface. The evaluation software **HYDROcom** is delivered free of charge with the instrument and allows the comprehensive, detailed and professional evaluation and presentation of the measuring data.

You may connect up to 32 (40 at the special version "40 channels") sensors and save all measured values. Various calculations with pre-defined or freely programmable formulas can be assigned to special channels that can be displayed and/or saved. The minimal and maximal values of all channels are stored permanently and can be displayed at any time.

3.2 Components of the instrument

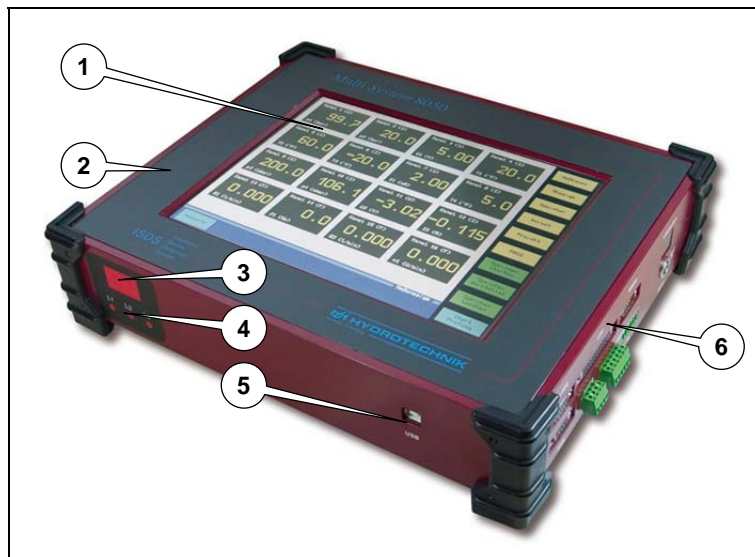

Pic. 1 Front view

1 TFT touch panel
2 Casing

3 Status indicator
4 Status-LED

5 USB interface
6 Right-side connectors



Pic. 2 Rear view

7 Rear side connectors

8 Main switch

9 Power supply jack

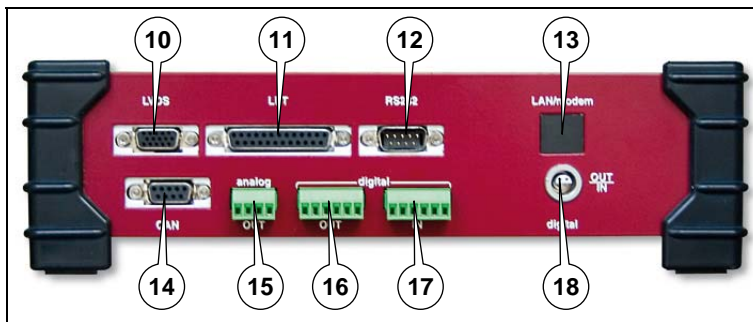

Pic. 3 Right-side connectors

10 LVDS interface

13 Option LAN/Modem

16 Digital outputs (2 – 4)

11 LPT interface

14 CAN interface

17 Digital inputs (2 – 4)

12 RS 232 interface

15 Analog outputs

18 Digital input/output (1)

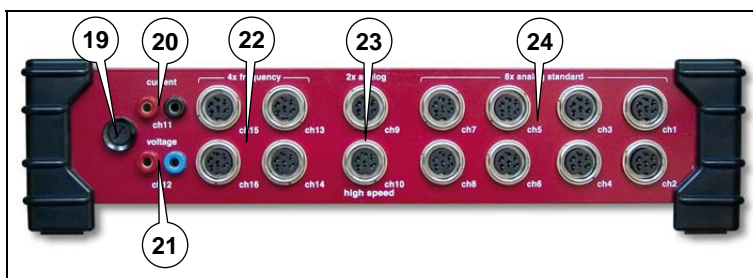

Pic. 4 Rear side connectors

19 Fuse

21 Input „Voltage“

23 2 highspeed analog inputs

20 Input „Current“

22 4 frequency inputs

24 8 analog inputs

Casing

The instrument has a solid aluminium casing equipped with corner protectors. The instrument is protected in accordance to IP 40 and weighs 3.1 kg. Further details are contained in the technical data.

Display

Display and operation are done with the 10.4" TFT monitor. This has full graphical abilities at a resolution of 800 x 600 pixels. Up to 30 channels can be displayed at the same time, the operation is done within logically structured menus.

Status indicator

The status indicator is a digital two-digit display and three red LED L1, L2 and L3. These are used to indicate error states, the displayed digits stand for an error code.

After switching the instrument on, all LED are lit and the firmware version of the instrument (SUB) is displayed with the digits. After the self-test, the LED will be off and "0" is displayed. If an error is present, LED "L1" flashes and the error code is indicated:

Code	Meaning
81	Error in the clock component
82	Error at analog outputs
83	Error at analog input „Highspeed 1“
84	Error at analog input „Highspeed 2“
85	Error at one or several analog inputs „Standard“
86	Error at the voltage or current input
88	Error at one or several frequency inputs
89	ISDS detection error
91	Error at a digital input or output

Check the respective component for damages. Then switch off the instrument and try it again. If the error remains, you should contact the Hydrotechnik customer service.



Reset of the measuring instrument





You can receive a special dongle from the Hydrotechnik customer support that can be used to reset the instrument to the factory settings. All user-specific programmings and settings will be lost during a reset.

Main switch

The main switch is used to enable or cut off the power supply of the measuring instrument. Please see section **Fehler! Verweisquelle konnte nicht gefunden werden.** on page **Fehler! Textmarke nicht definiert.** for hints on the correct switch on and off procedure.

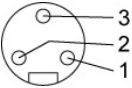
3.3 Connectors

Please see the illustration in section 3.2 starting on page 8. There you can see the positions of all connectors. The following table contains references to the position numbers shown there.

Position	Occupation
	USB interface
5	USB-plug connector type B, spec. 1.1, you may not connect any peripheral devices (hard disks, printers)
	Power supply jack
9	pin 1: minus, limitation 2.5 A, protection type PTC; pin 2: free; pin 3: + 24 VDC, limitation +33 VDC, 1.8 A, protection type transile diode BTC
10	LVDS interface to connect an external monitor; max. cable length 5 m
11	LPT interface (Centronics) to connect a printer, plug connector SubD 25-pol.
12	RS 232 interface for the universal data exchange; occupation: P1-DCD, P2-RXD, P3-TXD, P4-DTR, P5-GND, P6-DSR, P7-RTS, P8-CTS, P9-RI
13	Optional interface LAN/Modem or Ethernet the instrument can be equipped with an optional LAN/Modem- or an Ethernet-card; the corresponding jack will be installed here
14	CAN interface to connect Hydrotechnik CAN products (e.g. adapter boxes, sensors) or an external CAN environment; plug connector SubD 9-pol. pin 1: free; pin 2: CAN_L; pin 3: CAN_GND; pin 4: free; pin 5: CAN_SHLD; pin 6: GND; pin 7: CAN_H; pin 8: free; pin 9: free
	Analog outputs, channels 25 and 26
15	channel 25 (unipolar); pin 1: 0-20 mA, pin2: GND; max. voltage 0-10 V (with 499 Ω load resistor); resolution 12 bit; output rate 20 ms (aspired); accuracy < 1 %; terminal 1x channel 26 (bipolar); pin 3: ± 20 mA, pin 4: GND; max. voltage ± 10 V (with 499 Ω load resistor); resolution 12 bit; output rate 20 ms (aspired); accuracy < 1 %; terminal 1x
	Digital outputs, channels 22, 23 and 24, not separated galvanically
16	output: N-channel FET (open collector); load current: max. 10 mA; switching voltage: max. 30 VDC; link: diodes, or with internal 5 V supply over 825 Ω resistor; terminal pin 1: channel 22 OUT, pin 3: channel 23 OUT, pin 5: channel 24 OUT, pins 2, 4, 6: GND
	Digital inputs, channels 18, 19 and 20, not separated galvanically
17	input level: > 3.5-30 VDC; input resistor: 4.7 kΩ, 1 nF; frequency range: statically to 500 Hz; inverse polarity protection: diode; terminal pin 1: channel 18 IN; pin 3: channel 19 IN; pin 5: channel 20 IN; pins 2, 4, 6: GND
	Digital input/output (trigger), channels 17 and 21, separated galvanically
18	input level: > 3,5-30 VDC; input current: est. 1 mA constant current; input resistor depends on input level; frequency range statically to 500 Hz; reverse polarity protection diode; Lemos 4-pol. (2 pins) Trigger output: limitation $U_b / 10$ mA (U_V at mains supply 24 V), protection type VDR transile diode pin 1: signal; pin 2: ground; pin 3: signal +; pin 4: signal -
19	Fuse of the current input 2 A

Position Occupation

20 Analog input „Current“, channel 11
red jack: signal +; blue jack: signal –; Ri: 0,5 Ω; limitation: 90 VDC; protection type: VDR against ground; measuring range: ± 2 ADC; measuring rate: 1ms; measuring error: ± 1.0 % of FV; resolution: 11 bit + sign; ΔT: ± 0.1 % of measuring range per 10 °C; filter: PWM, integration time est. 250 ms / 100 ... 120 Hz; without filter integration time 5 ms

21 Analog input „Voltage“, channel 12
red jack: signal +; black jack: signal –; Ri: 100 kΩ, working resistor symm. 2 x 430 kΩ to ground; limitation: 90 VDC; protection type: VDR against ground; measuring range: ± 48 VDC; measuring rate: 1 ms; measuring error: ± 1.0 % of FV; resolution: 11 bit + sign; ΔT: ± 0.1 % of measuring range per 10 °C; filter: PWM, integration time est. 250 ms / 100 ... 120 Hz; without filter integration time 5 ms

Frequency inputs; channel 13 to 16

measuring range: > 0.25 Hz ... 5 kHz (with direction up to 2.5 kHz); input level: > 3.5 ... 30 VDC; measuring error: < 0.02 % ± 1 digit; direction detection: 90° phase shift; feed: Ub-2 VDC, max. 100 mA; filter: adjustable gate time; ISDS

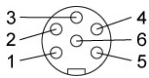

pin	1	2	3	4	5	6
function	signal	ground	Ub*	direction	shielding	ISDS
Ri.	4.7 kΩ	–	–	4.7 kΩ	–	1 Ω
Ci.	1 nF	–	–	1 nF	–	100 pF
limitation	33 VDC	–	100 mA	33 VDC	–	6.6 VDC
protection type	VDR Zener diode	–	current limitation PTC	VDR Zener diode	–	transile diode

Analog inputs „Highspeed“, channels 9 and 10

measuring range: 0-20 / 4-20 mADC, 0-10 / ± 10 VDC; measuring rate: 0.1 ms; error: ± 0.1 %; end value overstepping: < 15 % of measuring range; resolution: 13 bit + sign; ΔT: ± 0.03 % of measuring range per 10 °C; feed: Ub-2 VDC, max. 100 mA; filter: low pass filter 40 kHz; ISDS; scanning: 10 kHz

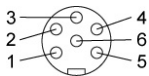

pin	1	2	3	4	5	6
function	signal 20 mA	ground	Ub*	signal +10 V	shielding	ISDS
Ri.	110 Ω	–	–	10 kΩ	–	1 kΩ
Ci.	0.022 μF	–	–	0.002 μF	–	100 pF
limitation	5.6 VDC	–	100 mA	+30 VDC	–	5.6 VDC
protection type	VDR Zener diode	–	current limitation PTC	VDR Zener diode	–	transile diode

Analog inputs; channels 1 to 8

measuring range: 0-20 / 4-20 mADC, 0-10 / ± 10 VDC; measuring rate: 1 ms; error: ± 0.1 %; end value overstepping: < 15 % of measuring range; resolution: 13 bit + sign; ΔT: ± 0.03 % of measuring range per 10 °C; feed: Ub-2 VDC, max. 100 mA; filter: low pass filter 5 kHz; adjustable software filter; ISDS; scanning: 1 kHz

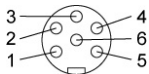

pin	1	2	3	4	5	6
function	signal 20 mA	ground	Ub*	signal +10 V	shielding	ISDS
Ri.	110 Ω	–	–	10 kΩ	–	1 kΩ
Ci.	0.22 μF	–	–	0.022 μF	–	100 pF
limitation	5.6 VDC	–	100 mA	+30 VDC	–	5.6 VDC
protection type	VDR Zener diode	–	current limitation PTC	VDR Zener diode	–	transile diode

4 Operation of the measuring instrument



Differing screenshots

In this manual screenshots are shown that were taken with a special software. Sometimes they look slightly different than what is displayed at the MultiSystem 8050, but the contents are always identical.

The operation of the measuring instrument is almost completely done with operation menus displayed on the touch-sensitive monitor. Only the switching on and off is done using the switch at the left side of the device.

4.1 Switch instrument on and off



Connect ISDS sensors first

If you use sensors with Hydrotechnik ISDS (Intelligent Sensor Detection System), you will have to connect them to the instrument before you switch it on. During the launch sequence the sensor data will be read and applied to the channel settings. If you connect ISDS sensors to a running instrument, you will have to switch it off and on to let the device read the sensor data.

The following preconditions must be fulfilled, before you switch the instrument on:

- an original power pack must be connected to the instrument and the supply voltage
- all desired ISDS sensors must be connected to the instrument

Now press the main switch (see position 8 in Pic. 2 on page 9) and switch it into position "I". The instrument starts a self-test and this screen will be displayed (among others):

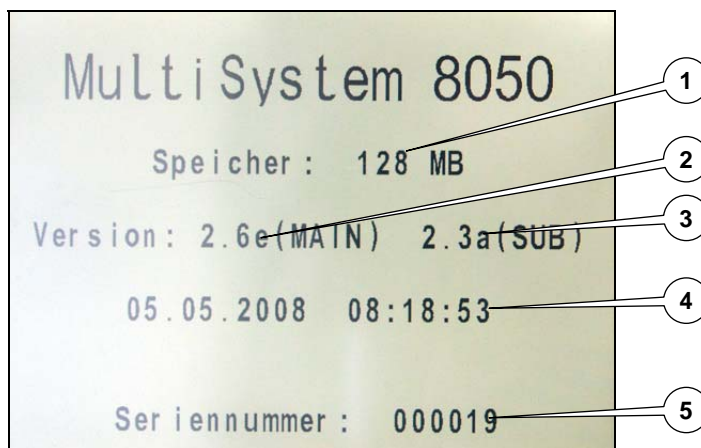

Pic. 5 Start screen

- | | | | | | |
|---|-------------------------|---|-----------------------------|---|---------------|
| 1 | Memory capacity CF-card | 3 | Firmware version sub system | 5 | Serial number |
| 2 | Firmware version Main | 4 | Date and time | | |

Several basic information on the instrument are displayed here. After some seconds, the measuring display will be shown:

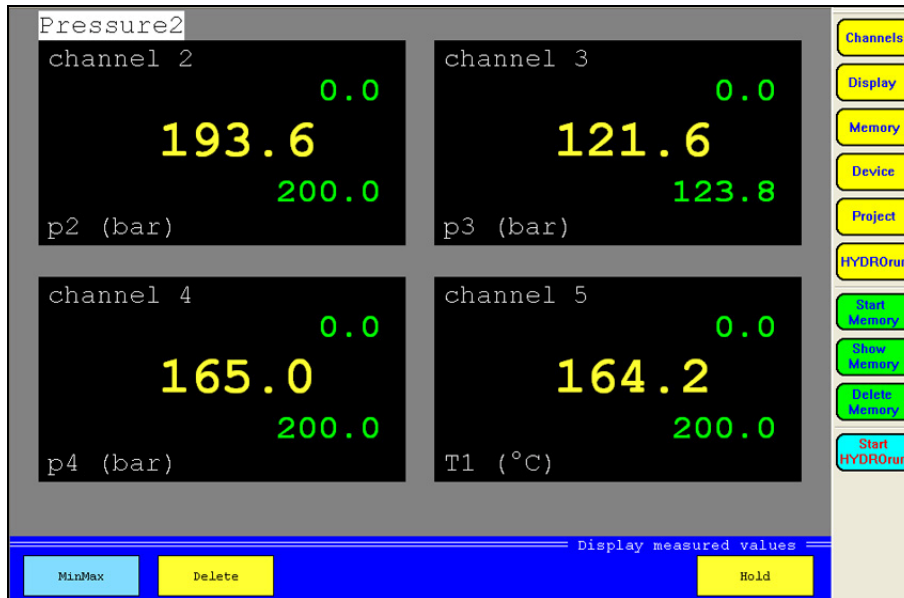

Pic. 6 Measuring display

The instrument is now ready for operation.

Switch instrument off

Wait until all store or write processes have ended and then press the main switch (see position 8 in Pic. 2 on page 9).

4.2 Elements on the screen

Nach dem Einschalten wird die Messanzeige dargestellt, der Bildschirm ist in drei Bereiche unterteilt:

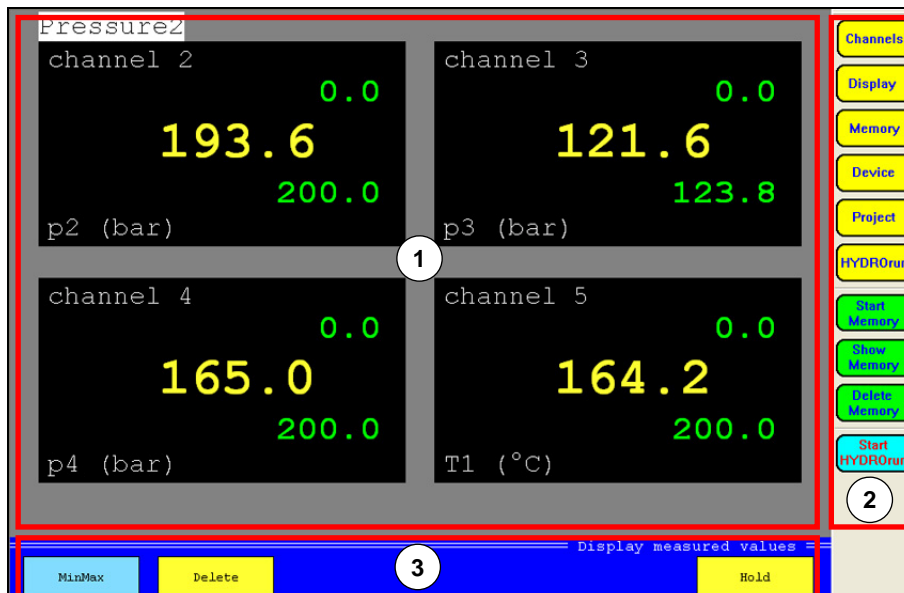

Pic. 7 Elements on the screen

- 1 data area: shows the current measured values, either numerically or graphically; the options of the menus are displayed here during menu operation

- 2 menu bar: the main menu (during the measured value display) or a possible submenu are displayed here
- 3 function bar: the buttons with the currently available functions are displayed here

4.2.1 Numerical measured value display

The measured values can be displayed numerically or graphically. This may be selected in the display menu. If display mode "TEXT" is selected, the measured values are shown numerically:

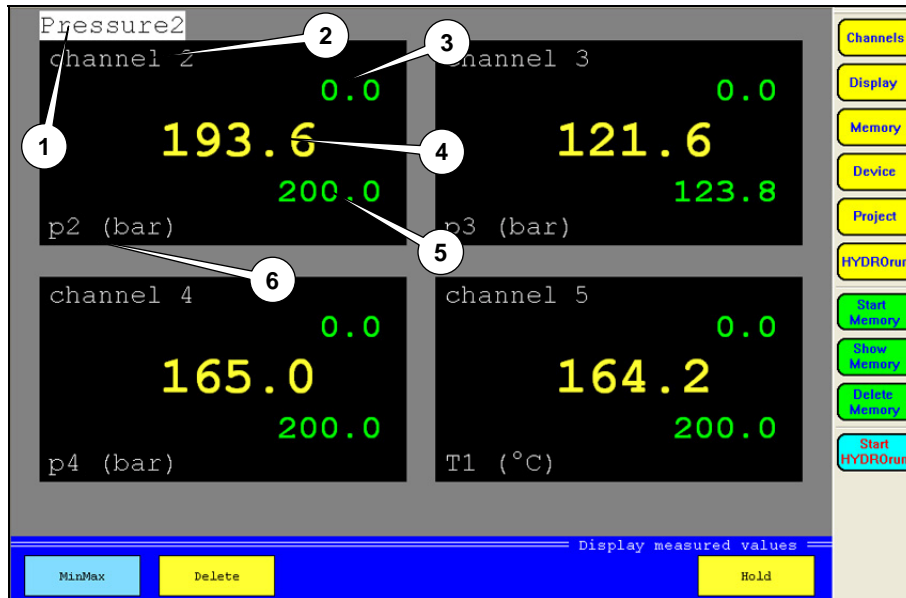

Pic. 8 Display mode „TEXT“

Here you may display up to 30 measured and/or calculated values at the same time. The number is selected in the display menu. Up to five information elements are shown for each channel:

- 1 channel name
- 2 channel number
- 3 minimal value (in MinMax mode, only)
- 4 current value
- 5 maximal value (in MinMax mode, only)
- 6 measurand with index and units

The function bar contains two (in measured value mode) or three (in MinMax mode) buttons:

- Meas.val./MinMax toggles between the modes; in MinMax mode, the minimal and maximal values since the last deletion are displayed together with the current measured value
- Delete (in MinMax mode, only) deletes the minimal and maximal values
- Hold displays the last measured value („freezes“ the display)



More buttons

In the memory mode the function bar contains more and different buttons. These will be explained in chapter 6 starting on page 42.

4.2.2 Graphical measured value display

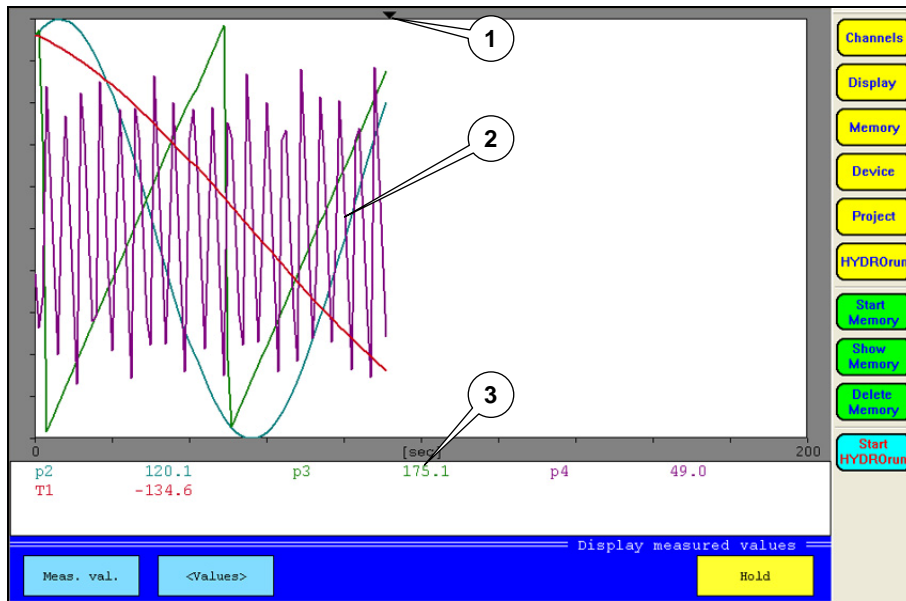

Pic. 9 Display mode „GRAPHIC“

Here you may display up to 30 measured and/or calculated values at the same time. The number is selected in the display menu. Three information elements are shown:

- 1 current position (current measured values)
- 2 curves of the measured values
- 3 numerical display of the current measured values or of the graphic scaling

The function bar contains three buttons:

- | | |
|------------------|--|
| Meas.val./MinMax | toggles the display modes |
| Values/Scaling | toggles between the numerical measured value display and the graphic scaling |
| Hold | displays the last measured value („freezes“ the display) |



Hint

When displaying MinMax values graphically you will mostly get a broad band of curves. These are the minimal and maximal values that appeared within the set display rate.

5 Menu operation



The menu bar contains the total of ten buttons:

Channels	configuration of all channels
Display	selection and configuration of the channels to be displayed
Memory	settings for the storing of measured values
Device	basic settings of the instrument
Project	management of instrument settings
HYDROrun	selection of automatic test procedures (only with a valid license of the software package HYDROgen / HYDROrun)
Start memory	start of the recording of measured values
Show memory	selection of recorded series of measurement for the display on the screen
Delete memory	deletion of recorded series of measurement
Start HYDROrun	start of the selected HYDROrun test procedure (only with a valid license of the software package HYDROgen / HYDROrun)

The first six buttons are used to open the six operation menus. These will be explained in the following sections of this chapter. The next three buttons are used to execute and evaluate data recordings and will be explained in chapter 6 starting on page 42. The lower button will be explained in chapter 7 on page 54.

General hints for the menu operation

Information are displayed with a color code in the dialogs. The colors mean:

white	information, only; no inter-activity
yellow	box can be selected
light-blue	touching toggles between the possible settings of the box
green	box is selected; setting is active
red	box cannot be selected

Virtual keyboards will be displayed for the input of texts and numbers, as soon as a corresponding input box has been touched:

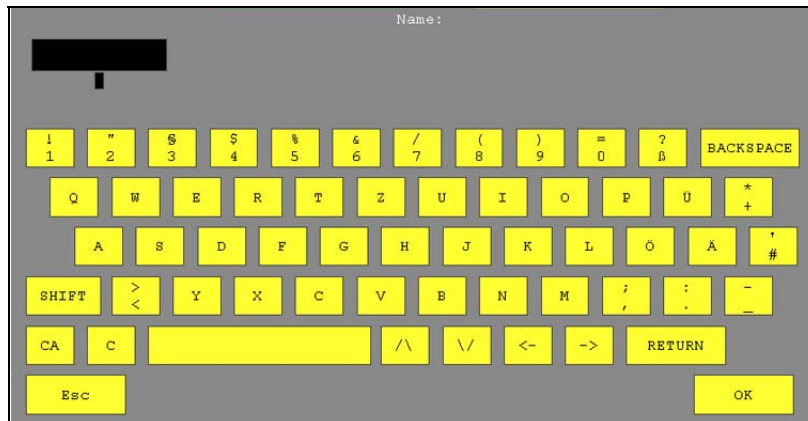

Pic. 10 Virtual keyboard

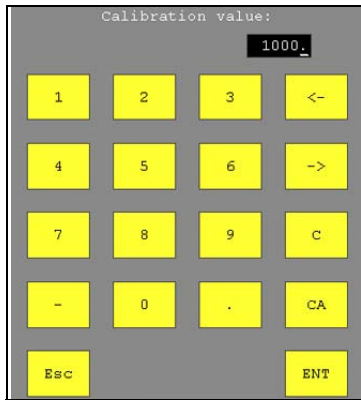

Pic. 11 Virtual 10-key pad

Enter the desired letters and/or numbers consecutively and then touch [OK] or [ENT] to confirm the entry.

5.1 Channel menu

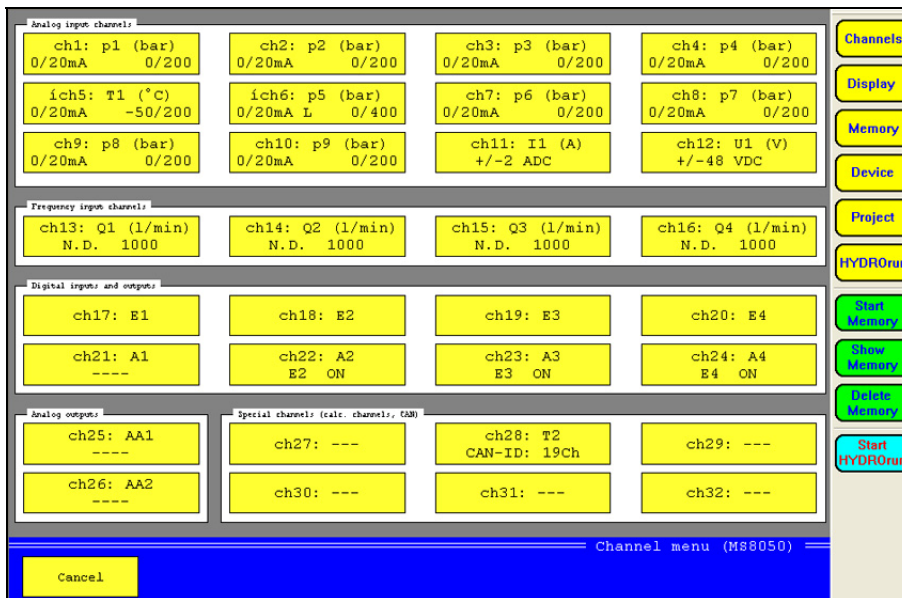

Pic. 12 Channel menu

All channels of the MultiSystem 8050 are displayed in this overview. Eight different types of channels can be distinguished:

Analog inputs	ch1 ... ch10; inputs for analog sensors, connected to the analog input jacks at the rear side of the instrument (see pos. 23 and 24 in Pic. 4 on page 9)
Inputs for current/voltage	ch11 and ch12; inputs for sensors connected to the input jacks at the rear side of the instrument (see pos. 20 and 21 in Pic. 4 on page 9)
Frequency inputs	ch13 ... ch16; inputs for sensors connected to the frequency input jacks at the rear side of the instrument (see pos. 22 in Pic. 4 on page 9)
Trigger input/output	ch17 and ch21; input or output for external trigger; connected to the jack at the right side of the instrument (see pos. 18 in Pic. 3 on page 9)
Digital inputs	ch18 ... ch20; inputs for digital signals, connected to the terminal at the right side of the instrument (see pos. 17 in Pic. 3 on page 9)
Digital outputs	ch22 ... ch24; outputs for digital signals connected to the terminal at the right side of the instrument (see pos. 16 in Pic. 3 on page 9)
Analog outputs	ch25 and ch26; outputs for analog signals connected to the terminal at the right side of the instrument (see pos. 15 in Pic. 3 on page 9)
Special channels	ch27 ... ch32; virtual channels for calculations and special functions (CAN)

5.1.1 Configuration of analog inputs (ch1 ... ch10)



No programming required for ISDS sensors

The analog input channels must only be configured, if sensors without ISDS are used. ISDS sensors must be connected to the instrument before it is switched on. Then the sensor data will be read during the start-up sequence.

Set	Real	Set	Real
0.000	0.000	0.000	0.000
0.000	0.000	0.000	0.000
0.000	0.000	0.000	0.000
0.000	0.000	0.000	0.000
0.000	0.000	0.000	0.000

Pic. 13 Configure analog inputs

- Variable touch the yellow box to open a screen with the available measurands; touch the desired measurand (observe units!) and then [OK]
- Name touch the entry box and use the virtual keyboard to enter the desired channel name
- Index variable this will be assigned to the selected measurand automatically; all channels with identical measurand will be numbered consecutively



Possible disadvantages of automatic indexing

The automatic indexing may influence the settings of different channels. If e.g. channels 1 and 4 are set to "p", channel 1 is "p1" and channel 4 is "p2". If you now set channel 2 to "p", the numbering will be updated: ch1 = p1, ch2 = p2, ch4 = p3. If you do not want this, you may switch off the automatic indexing in the device menu and assign the index numbers individually.

- Sensor type select the output signal of the sensor connected to the channel
- Measuring range touch the two entry boxes and enter the measuring range of the sensor
- Zero point the value of the last zero point alignment is displayed here (see below "Execute zero point alignment")
- Use linearisation touch this button to use a linearisation table, or to create a new table (see below)

Execute zero point alignment

1. Touch the button [New alignment].
2. A status bar is displayed during the zero point alignment is executed:

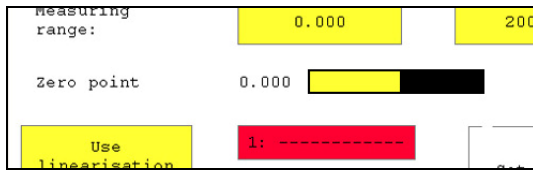

Pic. 14 Zero point alignment

3. The new value will be displayed after the alignment has been completed.

Use linearisation tables

The measuring accuracy of a sensor can be increased by using a linearisation table. The correction values determined during a sensor calibration will be taken into a table. These correction values should be contained in the calibration protocol of the sensor. You may enter max. five linearisation tables per channel.

1. Touch the button [Use linearisation]. The linearisation function is active as long as the button is green:

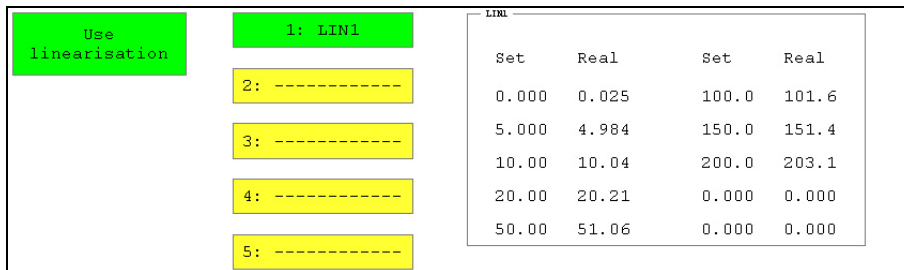

Pic. 15 Linearisation function

- The buttons for the selection of the linearisation table 1 to 5 are yellow now and can be selected. The values of the selected table are displayed in the rectangle. Table 1 is selected in the shown example.
2. Touch the button of the linearisation table that you want to use. If you want to create a new table, you should touch an "empty" button (here buttons 2 to 5).
 3. Touch the button [Edit lin. table]:

	Set	Real	Set	Real
1:	0.000	0.025	6:	100.0
2:	5.000	4.984	7:	150.0
3:	10.00	10.04	8:	200.0
4:	20.00	20.21	9:	0.000
5:	50.00	51.06	10:	0.000

Linearisation table parameters

Cancel OK

Pic. 16 Enter linearisation table

4. Touch the entry box „ID number“ and enter a name for the table.
5. Touch the entry box „1 – Set“ and enter the first set value (e.g. “0”).
6. Touch the entry box “1 – Real” and enter the first actual value (e.g. “0.25”). This entry assures that the instrument shows “0” when the sensor reports the measured value “0.25”. This compensates the measuring error in this range.
7. Repeat the steps 5. and 6. for all pairs of values that you want to use.
8. Touch the button [OK] to save the linearisation table.

5.1.2 Configuration of voltage/current inputs (ch11 / ch12)

Name:

Zero point 0.000

PWM (with filter)

U/I-channel setup (AD11)

Cancel Do zero point Delete zero point OK

Pic. 17 Configure inputs for voltage/current

Name touch the entry box and enter the desired channel name

Zero point the value of the last zero point equalisation is displayed here (see „Execute zero point equalisation” in section 5.1.1 starting on page 19)

PWM (with filter) touch this button to switch the PWM filter on and off; the input signal is smoothed with this filter (RC filter, PWM frequency 100 Hz, time constant T = 250 ms, tolerance 10%, measuring error 0.2% of final value)

5.1.3 Configuration of the frequency inputs (ch13 ... ch16)

The screenshot shows the 'Frequency channel setup (f1)' interface. It includes the following elements:

- Variable:** Q (l/min)
- Name:** [Empty box]
- Index variable:** 1
- Sensor type:** no direction (selected) and with direction
- Calibration value:** 1000.
- Use linearisation:** [Button]
- Linearisation table:**

Hz	Real	Hz	Real
0.000	0.000	0.000	0.000
0.000	0.000	0.000	0.000
0.000	0.000	0.000	0.000
0.000	0.000	0.000	0.000
0.000	0.000	0.000	0.000
- Bottom bar:** Cancel, Set to zero, Edit lin. table, OK

Pic. 18 Configure frequency inputs

Variable touch the yellow box and a screen with the available measurands will be opened; touch the desired measurand (obtain units!) and then [OK] there

Name touch the entry box and use the virtual keyboard to enter the desired name of the channel

Index variable this will be assigned to the selected measurand automatically; all channels with identical measurand will be numbered consecutively



Possible disadvantages of automatic indexing

The channel settings of different channels can be affected by automatic indexing. If e.g. the channels 1 and 4 are set to "p", channel 1 is "p1" and channel 4 is "p2". If channel 2 is set to "p", too, the channels will be newly indexed: ch1 is "p1", ch2 is "p2" and ch4 is "p3". If you do not want this, you can switch off the automatic indexing in the device menu and choose the index numbers freely.

Sensor type select whether a sensor with direction detection is connected

Calibration value this value is used to calculate the sensor impulses into the selected units;

Turbines 1000 impulses is always the reference value for turbines:

Impulses	Cal. value	1 impulse is
1000	1000	1 unit (e.g. 1 l)
1000	100	0.1 units (e.g. 0.1 l)
1000	30	0.03 units (e.g. 0.03 l)
1000	2500	2.5 units (e.g. 2.5 l)

Rotational sp. for rotational speed measurement you enter the number of impulses for one rotation; enter the prefix if required

Use linearisation touch this button to use a linearisation table, or to create a new table (see section „Use linearisation tables“ in section 5.1.1 starting on page 19)

5.1.4 Configuration of trigger in- and output (ch17 / ch21)

5.1.4.1 Trigger input (ch17)

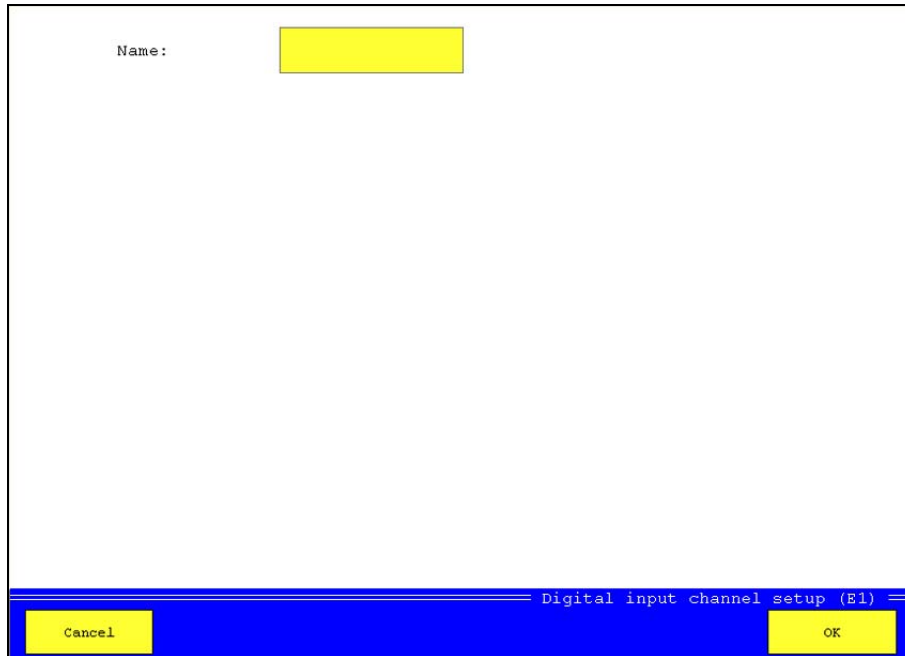

Pic. 19 Configure trigger input

You can only assign a name to the trigger input. Touch the entry box, enter the desired name and then touch [OK].

5.1.4.2 Trigger output (ch21)

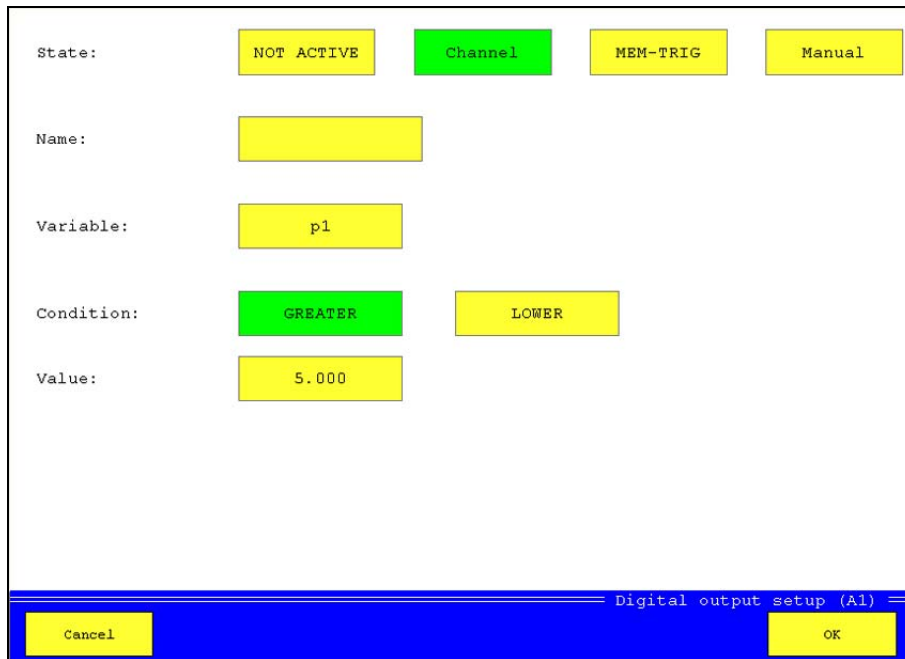

Pic. 20 Configure trigger output

State	select one of the available trigger modes:
Not active	trigger output is switched off
Channel	if the trigger condition happens on a channel, the trigger output will be switched
Mem-Trig	mode for the synchronisation of several measuring instruments; if storing is started by a trigger at the master instrument, the trigger output will be switched; at the slave device, the trigger input E1 must be selected as trigger incident
Manual	the trigger output is switched with a key pressure manually
Name	touch the entry box and use the virtual keyboard to enter the desired name of the channel
Variable	if you use the „Channel“ trigger you may touch this entry box and select the variable that shall be used for the trigger condition
Condition	select the desired trigger condition
Value	enter the value for the trigger condition



Example

In the screenshot shown above, the trigger output will be switched, if the measurand „p1“ exceeds the value „5.0“.

5.1.5 Configuration of digital inputs (ch18 ... ch20)

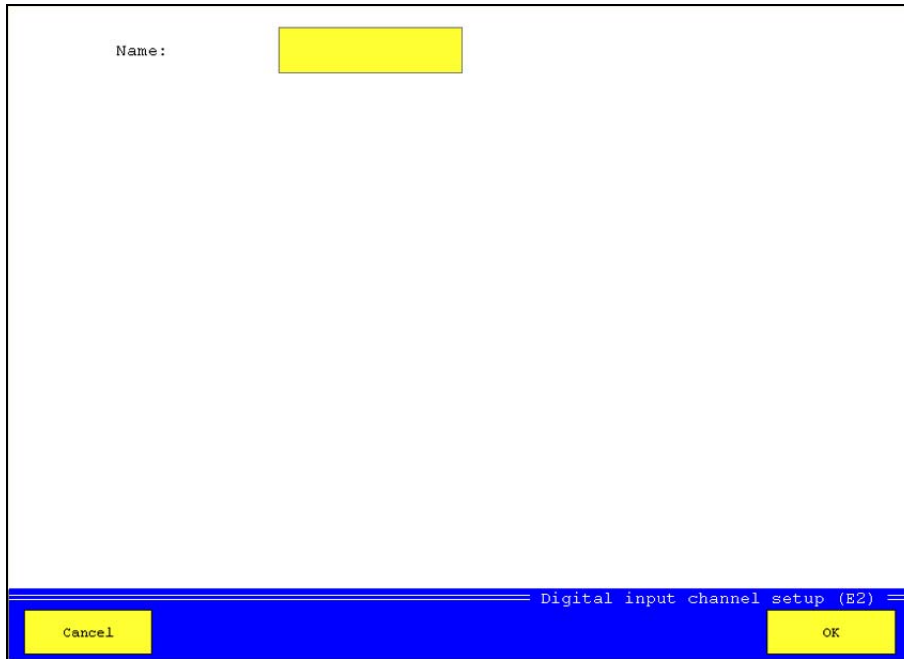

Pic. 21 Configure digital inputs

You can only assign a name to the digital inputs. Touch the entry box, enter the desired name and then touch [OK].

5.1.6 Configuration of digital outputs (ch22 ... ch24)

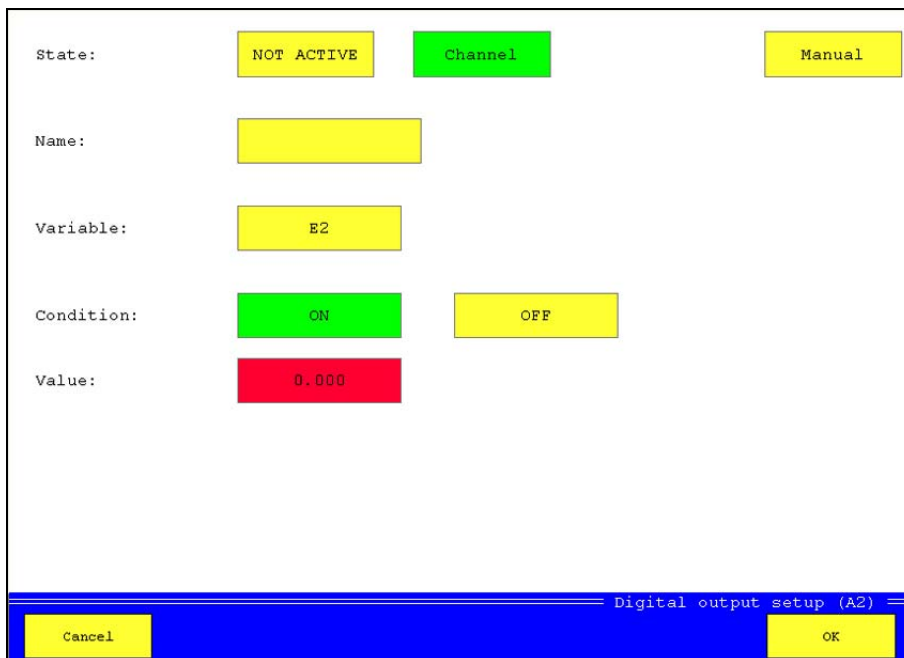

Pic. 22 Configure digital outputs

State	here you can select one of the available modes:
Not active	output is switched off
Channel	the output is switched if the defined condition happens
Manual	the output is switched manually by key pressure
Name	enter the desired name of the channel
Variable	you may touch this entry box in channel mode to select the channel that shall be used for the switch condition
Condition	select the desired switch condition
Value	enter the value for the switch condition (only for measured values)

In the example shown above, input E2 is used as switch condition. If this input is switched to "ON", the digital output will be switched.

5.1.7 Configuration of analog outputs (ch25 / ch26)

Pic. 23 Configure analog outputs

State	here you can select one of the available modes:
Not active	output is switched off
Active	the output is either be controlled by a channel, or the integrated signal generator
Name	enter the desired name of the channel
Signal source	select for an active output, how the output signal shall be generated

Signal source measuring channel

You can use any measuring channel and assign measured values to the output signals 0 or 20 mA. The output will then be switched to the output signal that corresponds with the current value of the selected channel.



Example

You use a measuring channel for pressure and define „Value for 0 mA = 0 bar“ and „Value for 20 mA = 300 bar“. The output will have the following signals for different measured values: 0 bar >>> 0 mA, 150 bar >>> 10 mA, 300 bar >>> 20 mA, 600 bar >>> 20 mA.

Signal source signal generator

- Start value value that will be emitted to the selected output immediately after starting the signal generator; min. 0 (ch25) or -20 (ch26)
- Stop value value that will be emitted at the end of the defined ramp (max. 20)
- Time start ramp time until the output is brought from the start to the stop value
- Stay time time how long the stop value is held
- Time stop ramp time after the stay time until the output is brought back to the start value
- Cycle pause if several impulses shall be generated, you can define the waiting time between two impulses
- No of cycles desired number of impulses

If the signal generator is activated, the button [Start generator] is displayed with the display of measured vales. If you touch this, the signal generator is started. You may use this e.g. to control a proportional valve.

5.1.8 Configuration of special channels (ch27 ... ch32)

The special channels can be used with predefined or freely definable formulas (calculated channels), or as CAN channels for the collection of values from a CAN bus.

5.1.8.1 Calculated channels

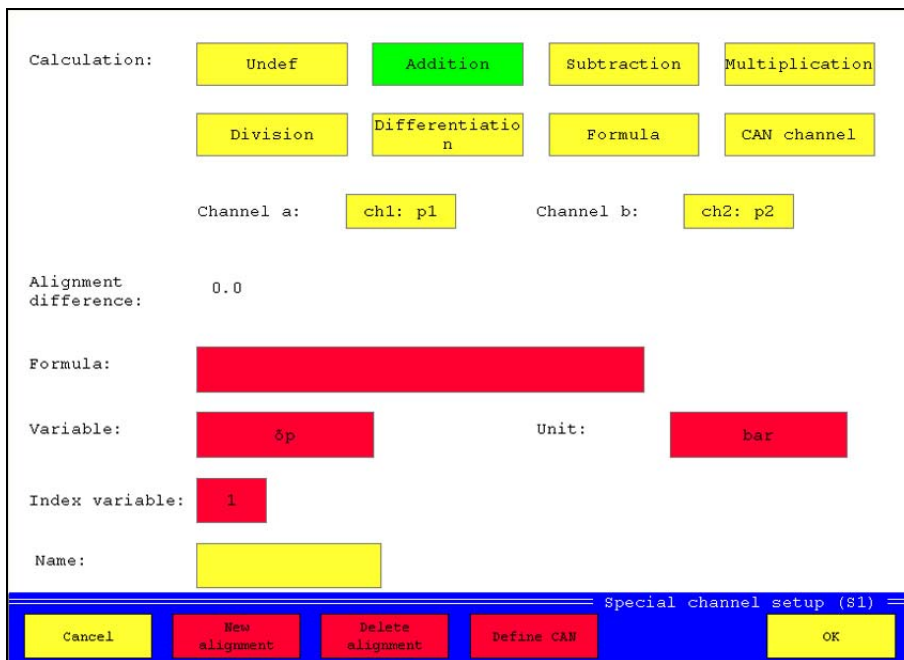

Pic. 24 Configure calculated channels

- Calculation** select one of the available channel settings:
 - Undef channel will not be used
 - Addition the addition of channels a and b (see below) will be executed with this channel
 - Subtraction the subtraction of channels a and b (see below) will be executed with this channel
 - Multiplication the multiplication of channels a and b (see below) will be executed with this channel
 - Division the division of channels a and b (see below) will be executed with this channel
 - Differentiation the differentiation of channels a and b (see below) will be executed with this channel
 - Formula an individual formula can be entered for this channel
 - CAN channel the channel will be used for the processing of CAN data
- Channel a/b** select which channels shall be used for the predefined formulas
- Alignment difference** the difference of the measured values of the selected channels (a/b) is measured and used as offset; touch the button [New alignment] to overwrite the existing value with a new determined value

Formula	enter a formula; you may include all measured channels and use all basic calculations together with the functions cos(), sin(), sqrt(), abs(), tan(), log(), ln() and exp(); do not enter blanks (example: ch1*ch13/600)
Variable	if a variable results from the calculation, you may enter a short name here
Unit	enter the units of the resulting variable
Index variable	this will be assigned to the resulting variable automatically; all channels with identical variable will be numbered consecutively



Possible disadvantages of automatic indexing

The channel settings of different channels can be affected by automatic indexing. If e.g. the channels 1 and 4 are set to "p", channel 1 is "p1" and channel 4 is "p2". If channel 2 is set to "p", too, the channels will be newly indexed: ch1 is "p1", ch2 is "p2" and ch4 is "p3". If you do not want this, you can switch off the automatic indexing in the device menu and choose the index numbers freely.

Name here you may enter a name for the channel

5.1.8.2 CAN channels

Enable the button [CAN channel] and then touch [Define CAN]:

Pic. 25 Configure CAN channel

CAN specification	select between „CAN 2.0A“ and „CAN 2.0B“
Identifier	enter the identifier of the desired signal on the CAN bus
Format	select the data format „Binary“, „CANopen“, „CANopen PDO“ or „Text“; dependant on the selected format, further definitions are available
Timeout	time in seconds that will be waited for signal from the CAN bus, before the error message „No signal“ will be emitted; the timeout should be longer than the transmission rate of the sensor
Offset	number of bytes coming before the data bytes
No of data bytes	number of bytes containing the desired data
Byte order	select between „Little Endian“ and „Big Endian“

Parameters for the formats CANopen and Binary

CAN value select between “signed” and “unsigned”
 from / to define the range of possible CAN values
 Meas. value define the measuring range corresponding with the range of CAN values

Parameters for the format CANopen

An additional filtering of the CAN data can be done by defining the two parameters.

Command enable the parameter and enter the command byte
 Index enable the parameter and enter the index bytes

Parameter for the format CANopen PDO

Decimal enter the desired number of decimal positions of the measured values

5.2 Display menu

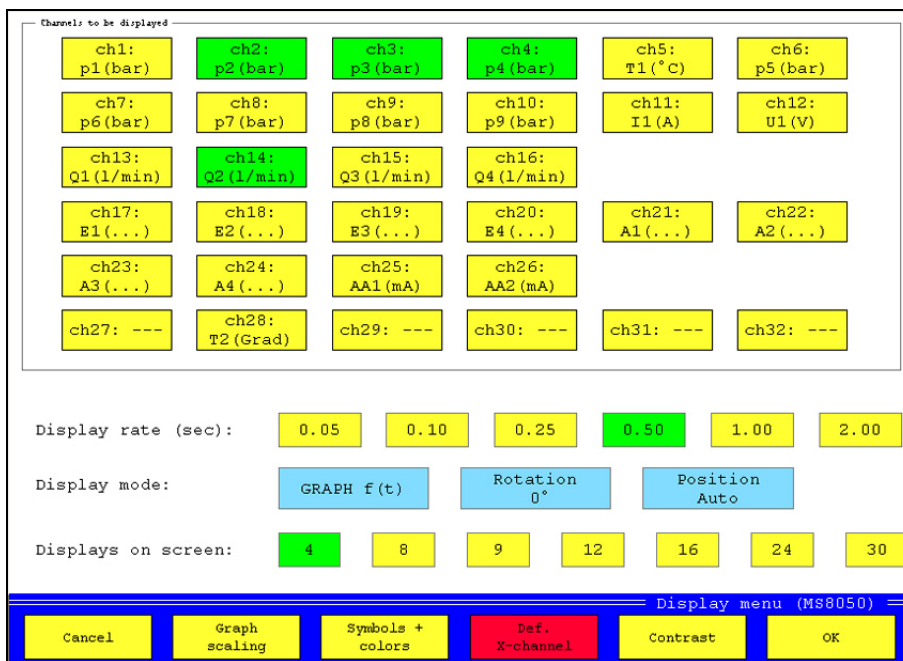

Pic. 26 Display menu

You may use the display menu to do all required settings to display the measured values in accordance to your individual requirements.

Select channels to be displayed

In the upper part of the screen, all channels that will be displayed are shown in green color. Yellow channels will not be displayed. Touch a channel to toggle the setting.

Configure display

Display rate select the rate, how often the display shall be refreshed; the settings „0.05“ and “0.10” are not available in “Text” mode
 Display mode select between „Text“ (numerical display of measured values), „Graph f(t)“ (curves on time base) and „Graph f(x)“ (curves based on a selectable channel); if the last mode is selected, the button [Def. x-channel] will be active; touch it and select the channel that shall be used as relational base of the displayed curve(s)

Rotation the display can be shown in normal orientation, or rotated by 180°
 Position in „Text“ mode you may select „Position manual“ and then position the measured value displays of the channels individually; during “Position Auto”, the channels will be positioned from left to right and from top to bottom
 Displays on screen select how many displays shall be shown simultaneously

Adapt scaling

Touch the button [Graph scaling] to display this screen:

	Minimum	Maximum		Minimum	Maximum		Minimum	Maximum
ch1: p1 (bar)	-5.00	20.00	ch2: p2 (bar)	-200	200	ch3: p3 (bar)	0	200
ch4: p4 (bar)	0	250.0	ch5: T1 (°C)	-200	200	ch6: p5 (bar)	0	400
ch7: p6 (bar)	0	25.50	ch8: p7 (bar)	0	200	ch9: p8 (bar)	0	200
ch10: p9 (bar)	0	200	ch11: I1 (A)	-2	2	ch12: U1 (V)	-50	50
ch13: Q1 (l/min)	-1100	1100.	ch14: Q2 (l/min)	0	1000	ch15: Q3 (l/min)	0	1000
ch16: Q4 (l/min)	0	1000	ch17: E1 (...)	-10	10	ch18: E2 (...)	-10	10
ch19: E3 (...)	-10	10	ch20: E4 (...)	-10	10	ch21: A1 (...)	-10	10
ch22: A2 (...)	-10	10	ch23: A3 (...)	-10	10	ch24: A4 (...)	-10	10
ch25: AA1 (mA)	-20	20	ch26: AA2 (mA)	-20	20	ch27: ---	0	100
ch28: T2 (Grad)	0	100	ch29: ---	0	100	ch30: ---	0	100
ch31: ---	0	100	ch32: ---	0	100			

Scaling measuring values for display (M88050)

Pic. 27 Adapt scaling

Here you may adapt the displayed range of each channel. If you have connected a sensor with a measuring range of 0 to 200 bar, but you only expect measured values between 50 and 100 bar, you can set the scaling to „Minimum = 50“ and „Maximum = 100“ to expand the displayed curve over the complete screen. This setting does not influence the range of measurement, values outside the scaling will be measured but not displayed.

Touch the entry boxes „Minimum“ and „Maximum“ of a channel and enter the desired values. Complete the adjustment by touching the button [OK].

Assign colors and symbols

This screen will be displayed after touching the button [Symbols + colors]:



Pic. 28 Assign colors and symbols

Here you can assign colors and symbols to the channels to distinguish their curves more easy.

Touch the blue buttons [Green] and [Rectangle], until the desired combination of color and symbol is displayed. Then touch the button of a channel to assign these settings. If you touch the color or symbol button of a channel, only the corresponding setting will be assigned. If you do not want to use symbols, you may disable the button [Use symbols].

Confirm the changes by touching [OK].

Set contrast

This screen will be displayed after touching the button [Contrast]:

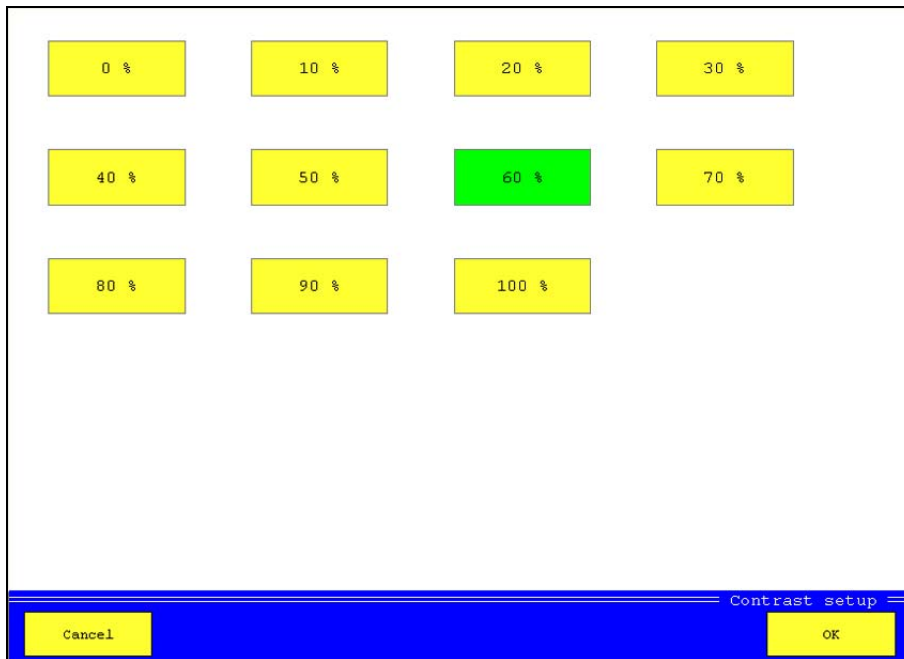

Pic. 29 Set contrast

Select the desired contrast and then touch [OK].

5.3 Memory menu

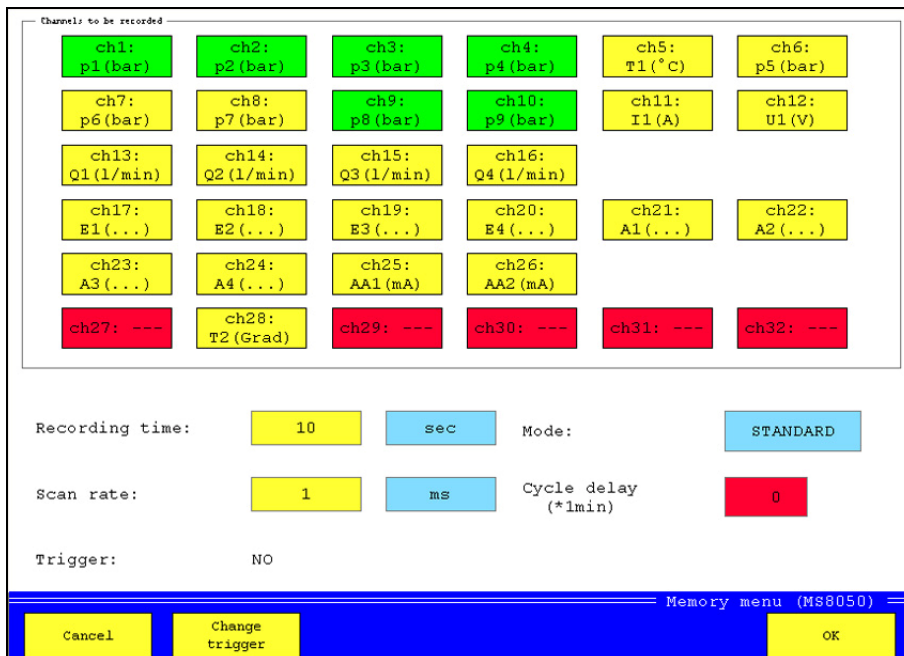

Pic. 30 Memory menu

All channels of the MultiSystem 8050 are displayed as rectangles in the upper part of the screen. The channels with green rectangles shall be recorded, the yellow channels not. Channels displayed in red color cannot be

Trigger-mode	select the desired trigger setting:
Not active	trigger is switched off
Channel	one or two channels will be used as trigger condition(s)
Key	triggering shall be done with key pressure
Pretrigger	percentage of the recording time that shall be applied to measured values BEFORE the trigger incident; for a recording time of 10 seconds and a pretrigger of 10 %, the measured values of the last second before, and the nine seconds after the trigger incident will be recorded
Trigger	select the channel that shall be used as trigger; the second box is only active, if a trigger links is selected
Trigger type	select one of the possible trigger conditions:
Greater	trigger condition is fulfilled, if the measured value exceeds the trigger value
Lower	trigger condition is fulfilled, if the measured value falls below the trigger value
Rising	trigger condition is fulfilled, if the measured value first falls for more than 5 % below the trigger value and then exceeds it (rising flank)
Falling	trigger condition is fulfilled, if the measured value first exceeds the trigger value for more than 5 % and then falls below it (falling flank)
Trigger value	enter the desired value for the trigger condition
Trigger link	select one of the available links of two trigger incidents:
None	no linking, only one trigger is active
And	recording starts, after both trigger incidents have happened
Or	recording starts, after one of the two trigger incidents have happened
Start/Stop	recording is started by the first trigger and stopped by the second

5.4 Device menu

The screenshot shows the 'Device menu' interface with the following settings:

- Language:** DEUTSCH, ENGLISH (selected), FRANCAIS, ESPANOL, ITALIANO, NEDERLANDS, SVENSKA
- Date:** 15.09.2008
- Time:** 14:06
- ISDS (Intelligent Sensor Detection System):** ISDS (selected), Unit: SI units
- Microcontrol:** Manual
- Instrument printer setup:** Controlled printer: HP mono, Printer type: HP 350C, Paper size: A4
- Can- Baud 10/20/50/125/250kBd:** Enable CAN bus (selected), Baud rate: 125 kBit/s
- Company:** Hydrotechnik GmbH, 65549 Limburg, Holzheimer Str.

At the bottom, there are navigation buttons: Cancel, Channel filter, Hardware setup, Logger, and OK. The title 'Device menu' is also visible in the bottom right corner of the menu area.

Pic. 32 Device menu

Language	select the desired operation language
Date	touch the date box and enter the current date
Time	touch the time box and enter the current time; use the dot as separation digit between hours and minutes
ISDS	enable or disable the automatic sensor detection ISDS; if ISDS is enabled, you can select between SI- and US-units

Channel filters of frequency inputs

The measuring instrument can read frequencies down to 0.05 Hz. But there may be time delays for low frequencies, before the value “0” is displayed. Therefore you can enter a minimal frequency here that you expect during your measuring task. If this frequency is fallen below, the value “0” will be displayed. You may enter the values 0.05, 0.25, 1, 10 or 100 Hz.

By entering a gate time you may smoothen frequency inputs. Then new measured values will be taken only after the entered time interval. If you enter “5”, new values will be taken each 50 ms. You may enter integer values between 1 and 100.

5.4.2 Hardware setup

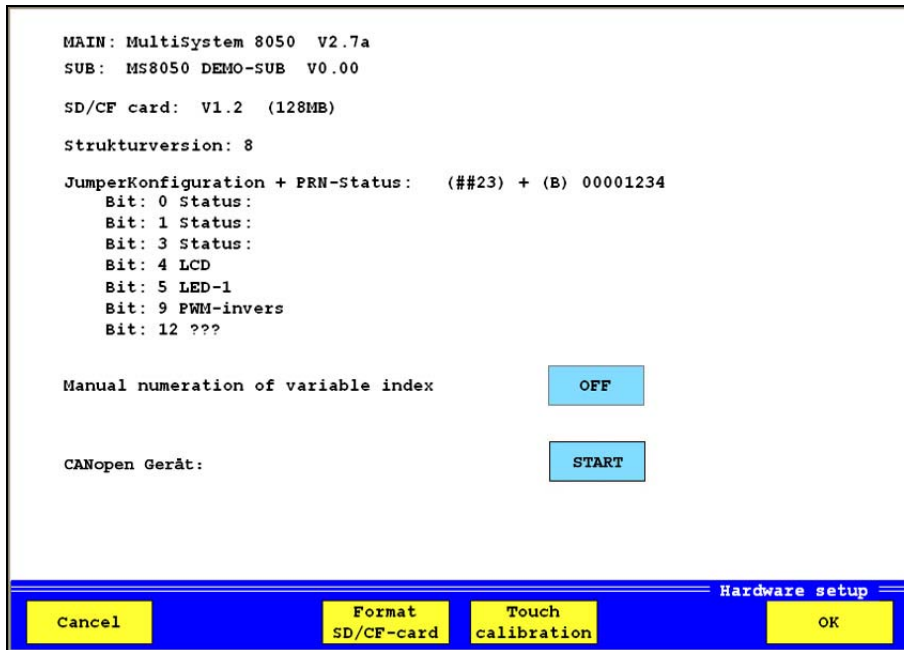

Pic. 34 Hardware setup



Possible loss of data

In this menu you can view and modify basic settings of the measuring instrument. Improper modifications may cause functional problems that may lead to unexpected reactions of the instrument and losses of data. The operation of this menu should be reserved to especially trained and qualified staff.

Information on the firmware version of the measuring instrument are displayed on the main screen of the hardware setup menu. Three functions can be used:

- Manual numeration if this function is enabled (ON), all channels with identic measurand will be numbered automatically; if it is (OFF), the index numbers can be assigned manually
- CANopen device sensors of a CAN bus does not send data automatically, they must receive a start command; you can trigger this command by touching this button



Possible loss of data

All contained data will be lost when a CompactFlash card is formatted. The formatting cannot be undone.

- Format CF card with this function you can format the CF card contained in the measuring instrument; by doing this, all data on the card will be lost

Touch calibration function to calibrate the touchscreen monitor; follow the instructions on the screen after starting this function

The functions available in the left bar give access to further information on the measuring instrument and the occupation of the memory:

Compact Flash

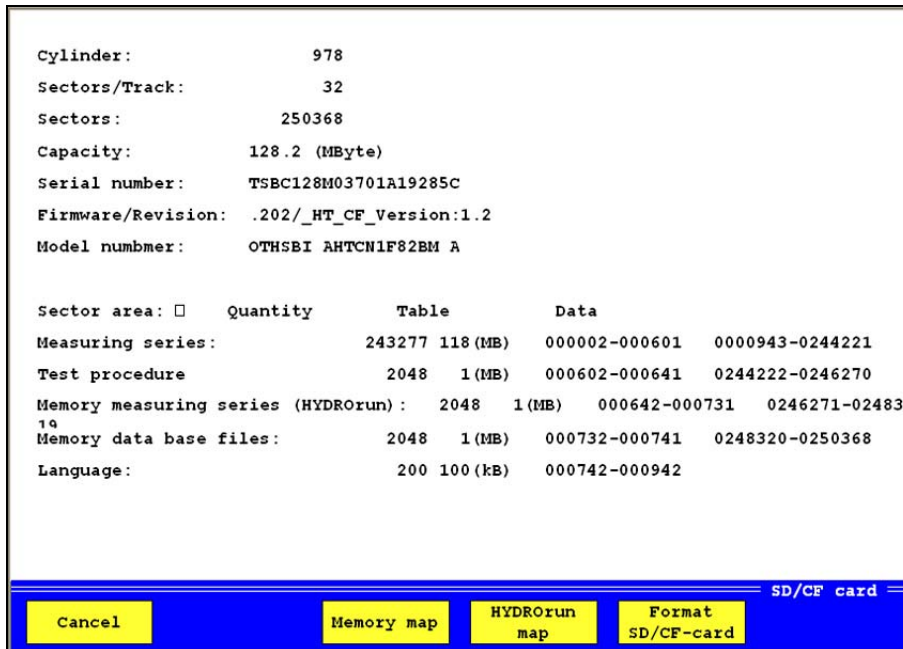

Pic. 35 Compact Flash information

Here you may view several information on the CF-card inserted into the instrument. Use the buttons to access further functions:

- Memory map here you can view the series of measurement contained on the CF-card and manage the memory
- HYDROrun map here you can view the HYDROrun test procedures contained on the CF-card and manage the memory



Possible loss of data

All contained data will be lost when a CompactFlash card is formatted. The formatting cannot be undone.

Format CF-card formats the CF-card; by doing this, all data contained on the card will be lost irretrievably

ISDS

Here you can view information on the connected ISDS sensors and read their most important data.

RS232

Here you may set the transfer speed of the RS232 interface.

5.4.3 Logger function

The measuring instrument can be operated as automatic data logger. Then a pre-defined recording will be started automatically after the device has been switched on. Here in the device menu, you can enable (green button) and disable (yellow button) this function.

5.5 Project menu

You may use the project menu to save complete instrument configurations and load them if required. This allows you to save the time for the manual setting of the desired parameters.

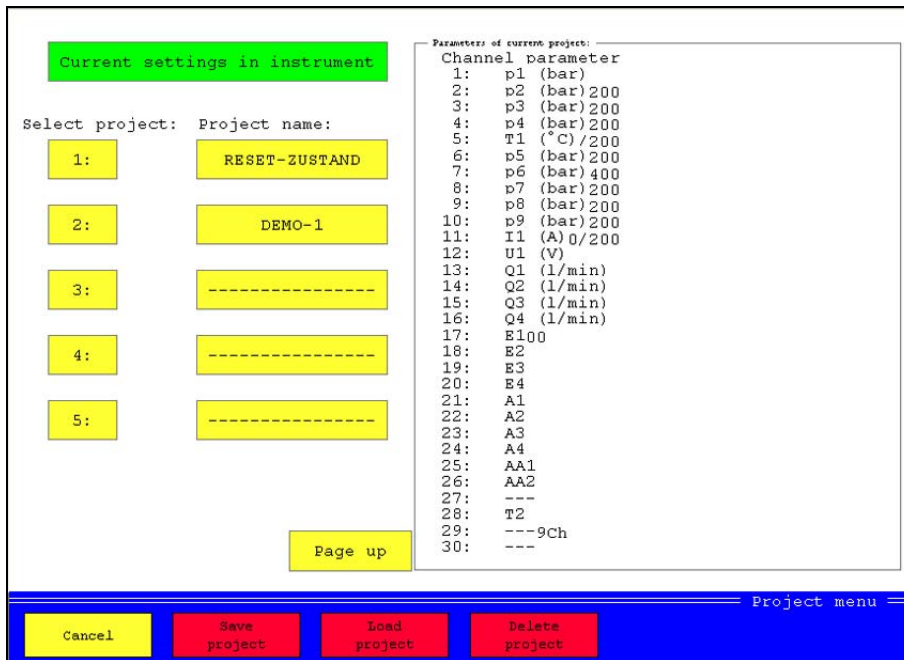

Pic. 36 Project menu

In the left half of the screen you can see the currently loaded configuration and a list of all saved projects. The channel settings of the current configuration are displayed in the list window.

Save a new project

You want to save the current configuration of the measuring instrument as a project.

1. Touch a project number.
2. Touch the button „Project name“ beside the selected number.
3. Enter a name and then touch [OK].
4. Touch the button [Save project].
5. Touch [Cancel] to leave the menu.

Load an existing project

You want to load a project and overwrite the current configuration of the instrument.

1. Touch the number of the desired project.
2. Touch the button [Load project].
3. Touch [Cancel] to leave the menu.

Delete a project

You want to delete a saved project definitely.

1. Touch the number of the desired project.
2. Touch the button [Delete project]; the project will be deleted without further confirmation.
3. Touch [Cancel] to leave the menu.

5.6 HYDRORun menu



License required

A valid license for your measuring instrument is required to use the HYDRORun functionality. Licenses from other instruments cannot be transferred. Please contact your Hydrotechnik partner in any case of question.

You can load and manage test procedures in the HYDRORun menu.

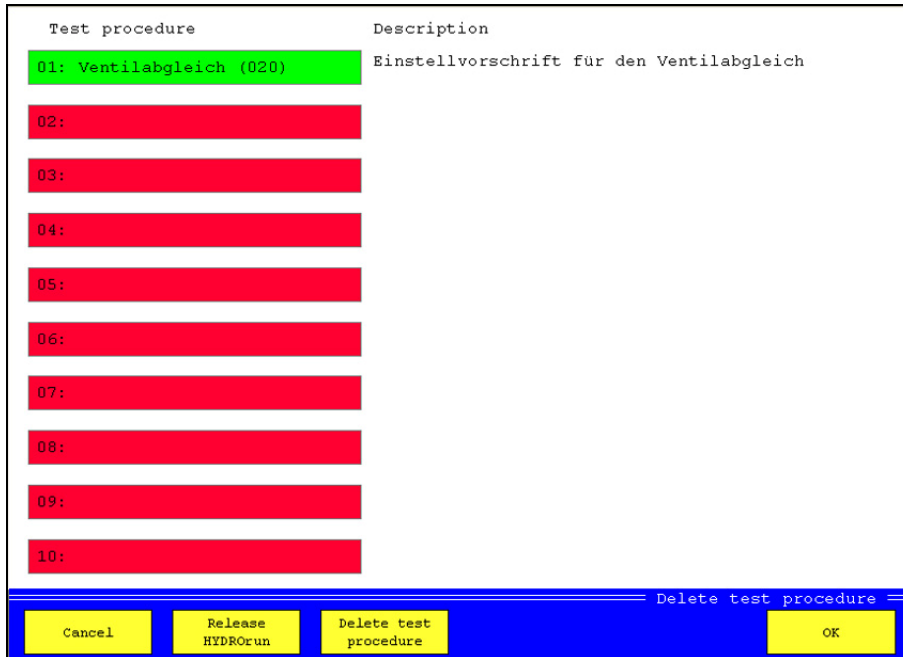

Pic. 37 HYDRORun menu

All test sequences contained in the instrument are displayed in the list.

Load test sequence

Touch the button with number and name of the test sequence. The button will then be displayed in green color. Touch [OK] to leave the menu.

Release HYDROrun



Pic. 38 Release HYDROrun

Here you may enter the release code purchased for the measuring instrument to activate the HYDROrun functionality. Additionally you can manage the memory reserved for HYDROrun.

The total available memory and the reserved measured value memory are displayed. The remaining rest can be distributed over the three types of use. Touch the button with the desired memory size.

- Memory test proc. memory reserved for HYDROrun test procedures
- Memory meas. ser. memory reserved for series of measurement recorded during the execution of HYDROrun test procedures
- Memory data base memory reserved for data bases recorded during the execution of HYDROrun test procedures

Touch [OK] to save the settings.

Delete test procedure

Touch [Delete test procedure]:

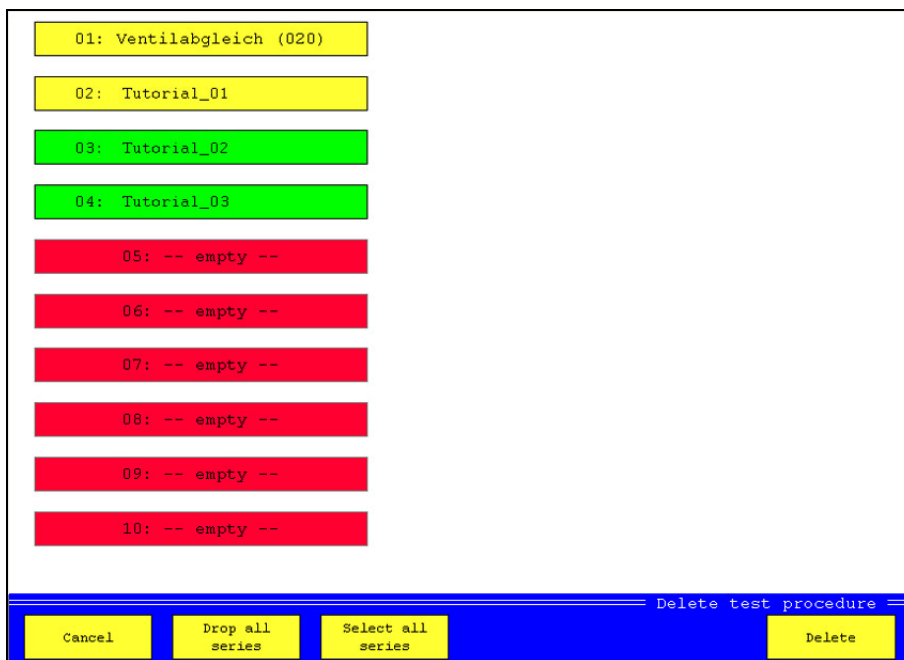

Pic. 39 Delete test procedures

Touch the test procedures that you want to delete. The buttons of the selected test procedures will be displayed in green color (here test procedures 03 and 04). Then touch [Delete] to erase the selected test procedures.

6 Record and present measured values

6.1 Record measured values



Configure recording first

Before you start to record series of measurement, you should execute the required configurations in the memory menu. Please obtain the information given in section 5.3 on page 32.

Initiate the recording of a series of measurement by touching [Start memory] in the right side button bar.

Pic. 40 Initiate recording

The current memory parameters like programmed in the memory menu (see section 5.3 on page 32) are displayed in the area „Parameters“.

- Meas. series as a standard, the current date and time are used as name of the series of measurement; touch the entry box and edit the name, if desired
- File specification touch the box and enter a name for the measured data file
- Note touch the box and enter a note

If all parameters and settings are correct, touch [OK] to start the recording. If no trigger condition has been defined, the recording starts immediately after touching the button. The measured values will be displayed and the recording progress will be indicated by a bar chart beneath the displays. After the recording has been completed, the data will be written on the CF-card.

If a trigger condition has been defined, the recording will start when this condition is fulfilled. If a pretrigger has been defined and there had not been enough time after the touching of [OK], the recording time will be shortened accordingly. Here is an example:

The recording time is 60 seconds, the pretrigger is set to 30% (= 18 sec.). The trigger incident happens five seconds, after the recording has been started by touching [OK]. Only these five seconds will be recorded as pretrigger, and the recording will be continued for 42 seconds (60 – 18 sec.) after the trigger incident. That totals up to a recording time of 47 seconds.

6.2 Present recorded series of measurement



Comfortable evaluation with HYDROcom

We recommend the Hydrotechnik software HYDROcom for the evaluation of recorded measuring data. As user of the MultiSystem 8050 you may use this tool free of charge. Install the software from the data CD or contact your local Hydrotechnik partner.

The measuring instrument MultiSystem 8050 offers some basic functionality for the evaluation and presentation of recorded measuring data that can be accessed by touching the button [Show memory] in the right menu bar.

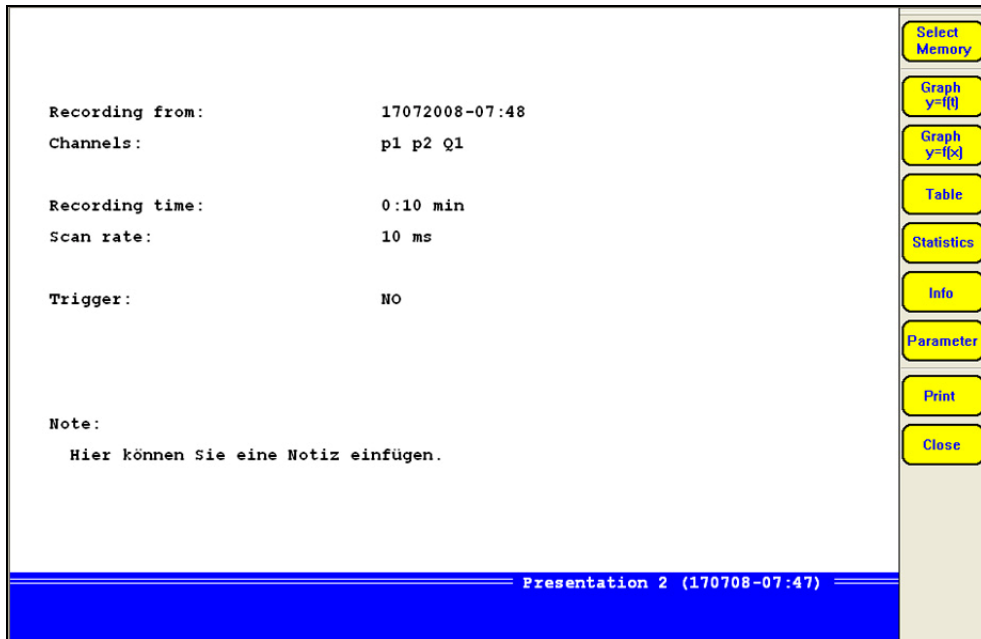

Pic. 41 Present series of measurement

All parameters of the current series of measurement are shown in the large screen section. The available functions are shown on the right side.

6.2.1 Select series of measurement

Touch the button [Select memory]:



Pic. 42 Select measurement data

The currently selected series of measurement is displayed in green color. Touch the button of a different series and then [OK] to select these data for presentation.

Move down/up if more series are recorded than can be displayed on one page, you can use these buttons to display hidden pages

Show file names touch this button if you do not want to see the name of the series of measurement, but that of the measured data file

6.2.2 Assign presentation parameters

Touch [Parameter]:

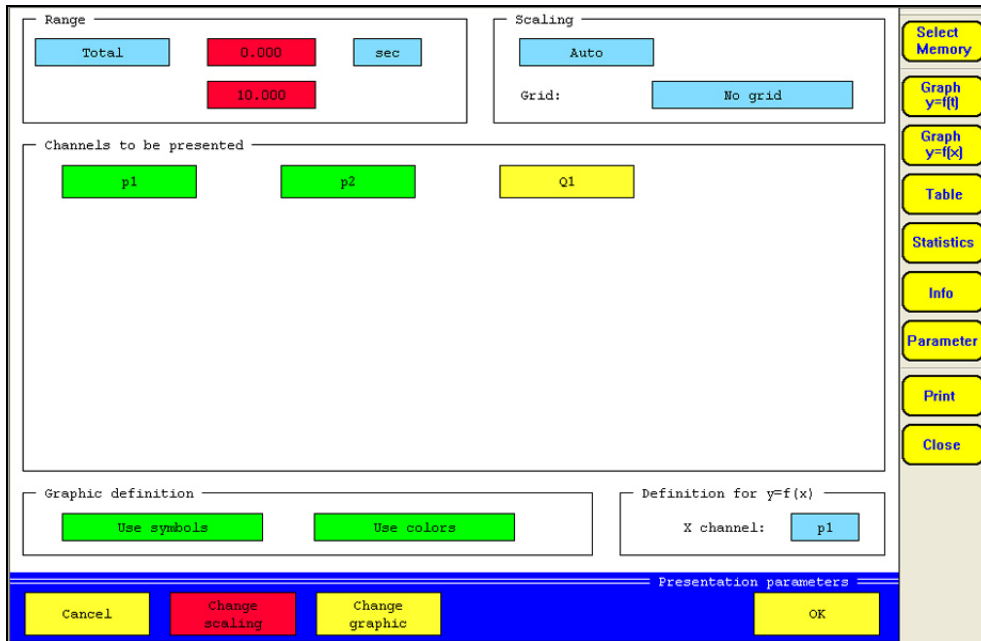

Pic. 43 Adapt presentation parameters

Define range of presented data

Either select „Total“ (= complete series of measurement will be presented) or „Partly“ in the section ‘Range’. Then you can select a time unit and the range of the data to be presented. Enter a start and an end time.

Adapt presentation scaling

In the section 'Scaling' you may choose between „Auto“ (automatic scaling) and „Manual“. Then you may touch [Change scaling] and adapt the scaling manually:

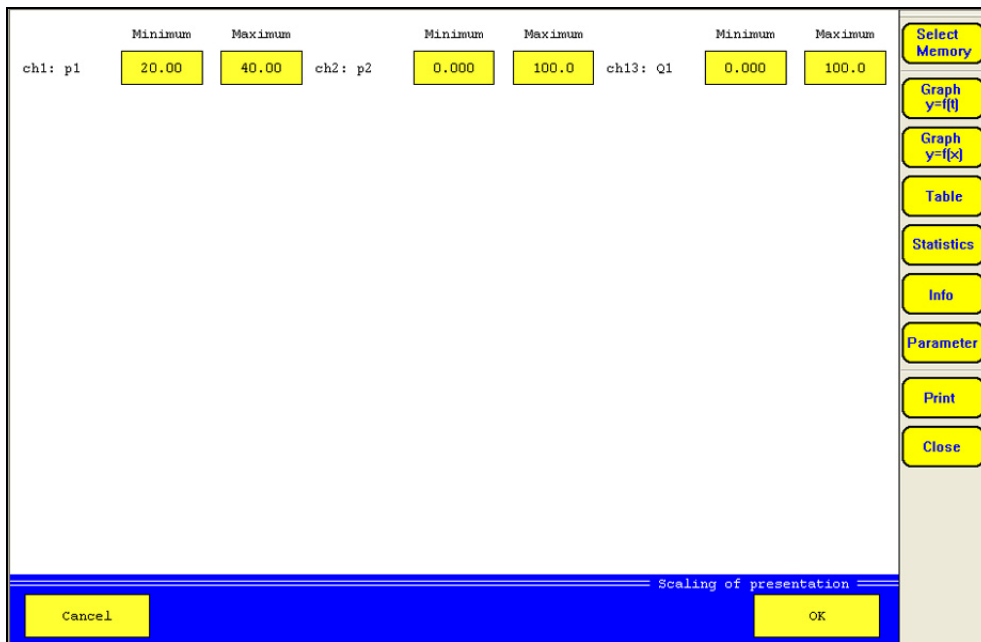

Pic. 44 Adapt scaling

Normally the complete measuring range of a channel is presented at the y-axis percentally. If the measured data comprise just a part of the measuring range, you may enter differing percentages here. By doing this, the curve will be spread and can be analysed better.



Measured data will not be presented

If you reduce the scaling too far and measured data are outside the entered percentages, they will not be contained in the graphical presentation.

Display grid lines

Select in the section 'Scaling', whether you want to display no, five, or ten grid lines, or the zero line, only.

Select variables for presentation

All variables contained in the measured data file are displayed in the center part of the screen. Variables displayed in green color will be presented, yellow variables not. Touch the button of a variable to toggle the setting.

Adapt graphic definition

In the section 'Graphic definition' you may select, whether symbols and colors shall be used in the presentation. Touch [Change graphic] to modify the appearance of the graphic:

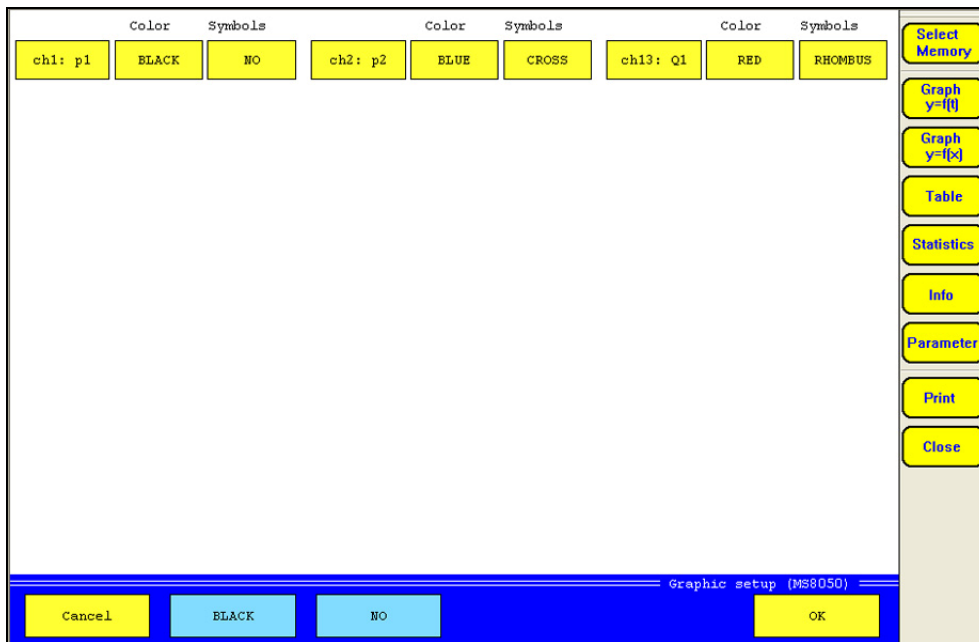

Pic. 45 Adapt graphic settings

The current settings are displayed for all variables. Touch the light-blue buttons [Black] and [No] at the bottom, to select the desired setting for a variable.

Then touch the button of a variable to assign both settings. If you want to assign one of the settings, only, you should touch the color or the symbols button of the variable. Repeat this for all variables and then touch [OK].

Select reference variable

If you want to use the presentation type „Graph $y = f(x)$ “, you may select the variable that shall be used as reference for the curve. Touch the button “x-channel” repeatedly, until the desired variable is displayed.

6.2.3 Present series of measurement

After selecting the desired series of measurement and doing the required graphic definitions, you may touch one of the buttons in the right button bar:

Graph $y = f(t)$	curve presentation with reference to „Time“
Graph $y = f(x)$	curve presentation with reference to a variable
Table	tabular presentation of the measured values
Statistics	several statistical evaluations of the series of measurement

6.2.3.1 Graph $y = f(t)$

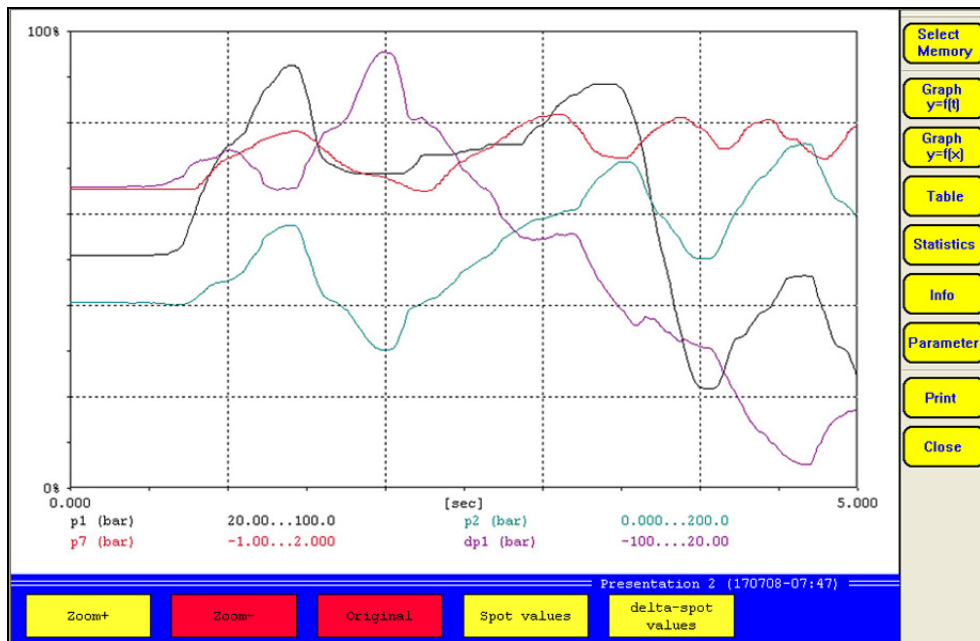

Pic. 46 Graph $y = f(t)$

You may use three tools to analyse the graphic:

Enlarge parts

1. Touch [Zoom +].
2. Touch the left, upper corner of the graphic section that you want to enlarge.
3. Touch the right, lower corner of the graphic section that you want to enlarge.

The selected part will be displayed. Now you may use [Zoom +] to continue zooming into the graphic, or undo the zooming step-by-step touching [Zoom -], or touch [Original] to display the complete graphic.

Use spot values

Touch [Spot values]:

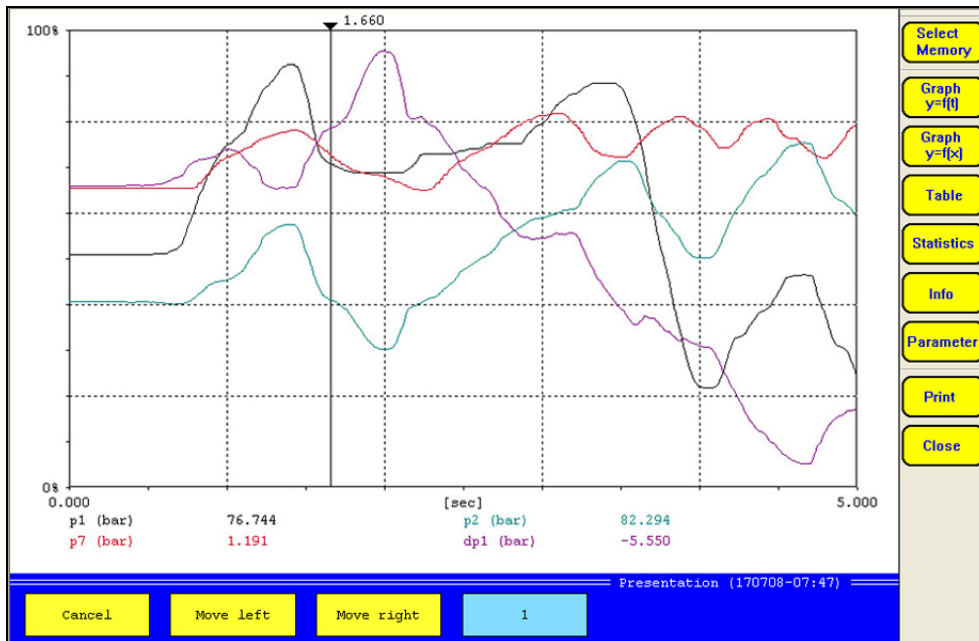

Pic. 47 Use spot values

A vertical line is displayed in the graph, below you can see the values of all curves, where they are crossed by this spot line. This is how to move the spot line:

- touch a position in the graph
- select a step width (1 / 10 / 50 / 100 / 500 / 1000) with the light-blue button [1] and then touch [Move left] or [Move right] to shift the spot line with the selected step width

Use delta spot values

Touch [delta-spot values]:

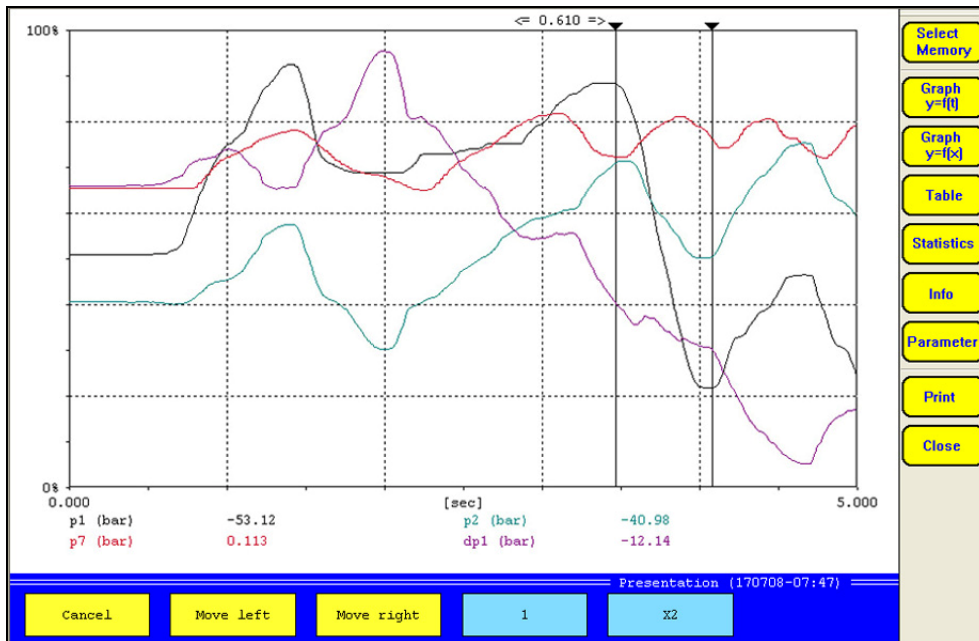

Pic. 48 Use delta spot values

Two vertical lines are displayed in the graph, below you can see the difference values of all curves between the position, where the spot lines cross the curves. This is how to move the spot lines:

- touch the button [X2] to select either the right (X1), left (X2), or both (X1 + X2) lines for the movement
- either touch a position in the graph, or ...
- touch the light-blue button [1] to select a step width (1 / 10 / 50 / 100 / 500 / 1000) and then touch [Move left] or [Move right] to shift the selected spot line(s)

6.2.3.2 *Graph $y = f(x)$*

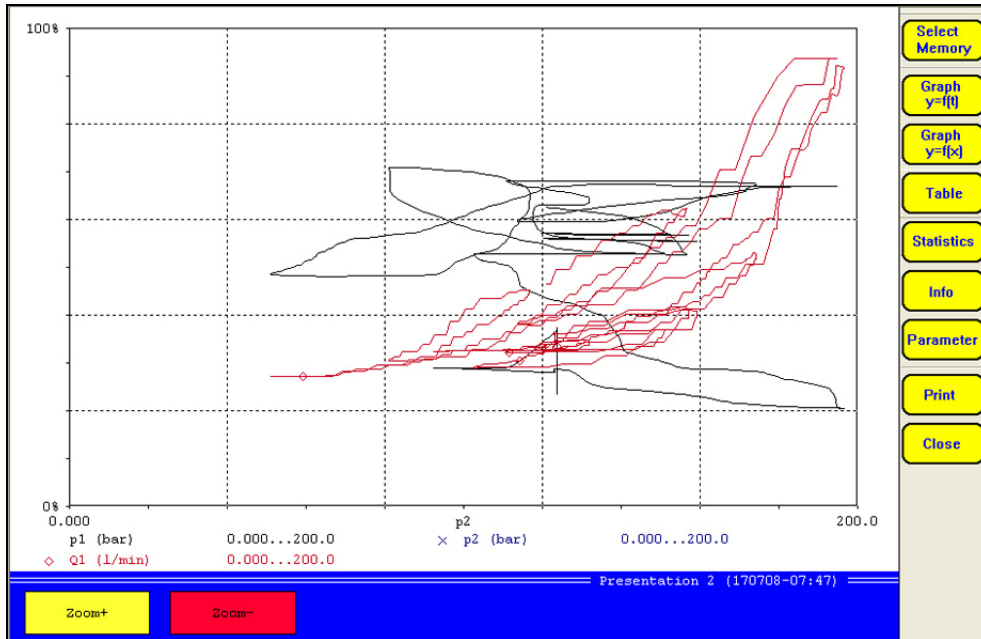

Pic. 49 *Graph $y = f(x)$*

Here you may use the zoom function, only (see section 6.2.3.1 on page 48).

6.2.3.3 *Table*

[sec]	p1 (bar)	p2 (bar)	Q1 (L/min)
0,00	47.391	123.743	67.280
0,50	48.394	123.743	67.138
1,00	75.023	123.743	66.809
1,50	58.071	103.829	65.397
2,00	58.092	95.126	65.084
2,50	57.646	123.130	72.464
3,00	41.573	187.514	150.905
3,50	57.542	164.066	91.771
4,00	85.292	127.081	67.334
4,50	102.682	105.668	59.626
5,00	109.183	146.647	73.837
5,50	114.610	120.378	65.764
6,00	128.990	132.070	69.499
6,50	135.547	171.689	96.544
7,00	119.181	117.500	76.480
7,50	134.265	165.105	140.964
8,00	113.718	81.336	59.453
8,50	96.544	82.828	59.267
9,00	140.737	96.743	77.435
9,50	109.232	121.667	79.407
10,00	125.625	120.935	93.359

The screenshot shows a table view of the data. The table has four columns: [sec], p1 (bar), p2 (bar), and Q1 (L/min). The control panel on the right contains buttons for 'Select Memory', 'Graph y={t}', 'Graph y={x}', 'Table', 'Statistics', 'Info', 'Parameter', 'Print', and 'Close'. At the bottom of the table area, there are 'Detail', 'Reset', 'Move up', 'Move down', 'Move left', and 'Move right' buttons. The status bar at the bottom right shows 'Presentation 2 (170708-07:47)'.

Pic. 50 *Table*

The data from the series of measurement are shown as a table. Due to the limited space, only the first and the last value, together with some intermediate values are displayed at first. Touch [Detail] to display further intermediate values:

5,00	109.183	146.647	73.837
5,50	114.610	120.378	65.764
6,00	128.990	132.070	69.499
6,50	135.547	171.689	96.544
7,00	119.181	117.500	76.480
7,50	134.265	165.105	140.964
8,00	113.718	81.336	59.453
8,50	96.544	82.828	59.267
9,00	140.737	96.743	77.435
9,50	109.232	121.667	79.407
10,00	125.625	120.935	93.359

Detail
Reset
Move up

Pic. 51 Select intermediate values

The time values of each line of the table are displayed as buttons after touching [Detail]. Touch one of these buttons, to display the intermediate values between this and the next line:

[sec]	p1(bar)	p2(bar)	Q1(L/min)
7,00	119.181	117.500	76.480
7,02	119.181	121.444	77.954
7,04	119.285	126.293	80.489
7,06	119.292	131.659	84.664
7,08	119.717	138.348	84.664
7,10	121.076	144.131	90.574
7,12	122.622	149.671	101.985
7,14	124.399	153.176	106.595
7,16	127.074	157.510	110.351
7,18	129.638	161.983	116.189
7,20	131.554	167.982	120.715
7,22	133.004	173.076	146.929
7,24	133.672	178.818	155.553
7,26	134.000	184.726	176.263
7,28	134.174	191.416	176.949
7,30	134.202	193.645	187.430
7,32	134.195	194.649	187.430
7,34	134.188	194.983	187.430
7,36	134.174	194.983	187.453
7,38	134.153	194.927	187.430
7,40	134.174	194.593	187.453

Detail
Reset
Move up
Move down
Move left
Move right

Select Memory
 Graph y={t}
 Graph y={x}
 Table
 Statistics
 Info
 Parameter
 Print
 Close

Pic. 52 Intermediate values

Now the intermediate values beginning with time value 7.0 seconds are displayed. Now you may:

- Detail display further intermediate values (see above)
- Reset return to the prior display
- Move up display lines above the current selection
- Move down display lines beneath the current selection
- Move left display columns left of the current selection
- Move right display columns right of the current selection

6.2.3.4 Statistics

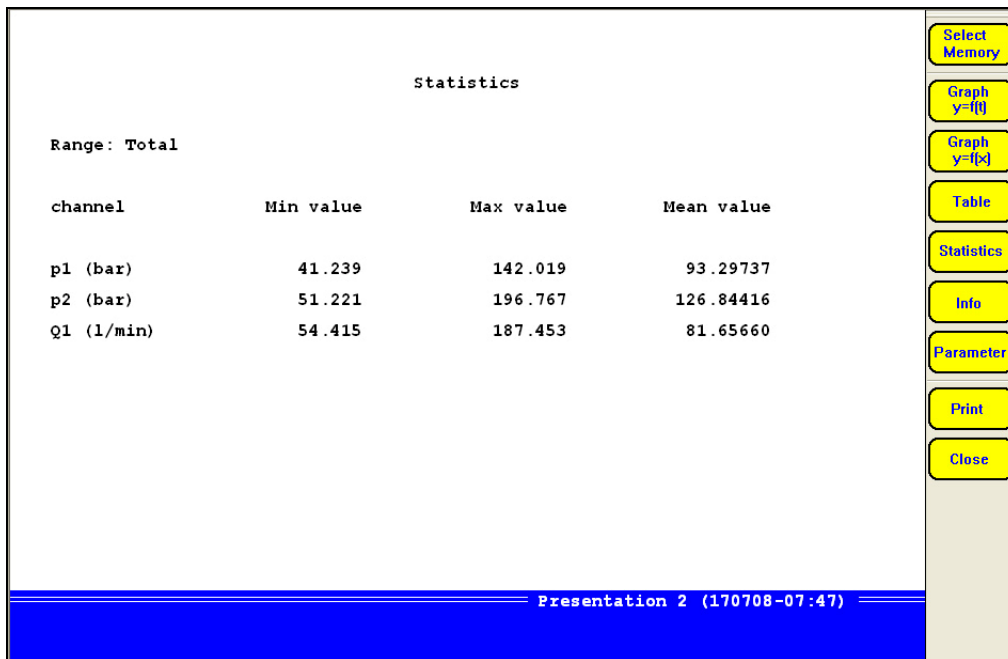

Pic. 53 Display statistical data

The minimal (Min value), maximal (Max value) and the arithmetical mean value (Mean value) are displayed vor all variables of the series of measurement.

7 Automatic test procedures with HYDRORun



License required

A valid license for your measuring instrument is required to use the HYDRORun functionality. Licenses from other instruments cannot be transferred. Please contact your Hydrotechnik partner in any case of question.

You can make your measuring instrument to a mobile test bench by executing predefined test procedures. Test tasks will be executed systematically in accordance to the prescriptions, the results are recorded and documented in the desired way. By the use of several data bases, all intermediate steps and results remain available and allow the complete reconstruction of a test procedure. All results are always reproducible.

HYDRORun is the execution component of the software package **HYDROgen / HYDRORun**. Use **HYDROgen** to generate test procedures in a comfortable programming environment, programming knowledge is not required. Hydrotechnik delivers a comprehensive operating instructions manual with the software, a tutorial and trainings are available on request.

Start a test procedure



Select test procedure first

Before you start the current test procedure, you should verify that the right one is loaded. Please see the hints in the **HYDRORun** menu (section 5.6 starting on page 39).

Touch [Start HYDRORun] in the right button bar:

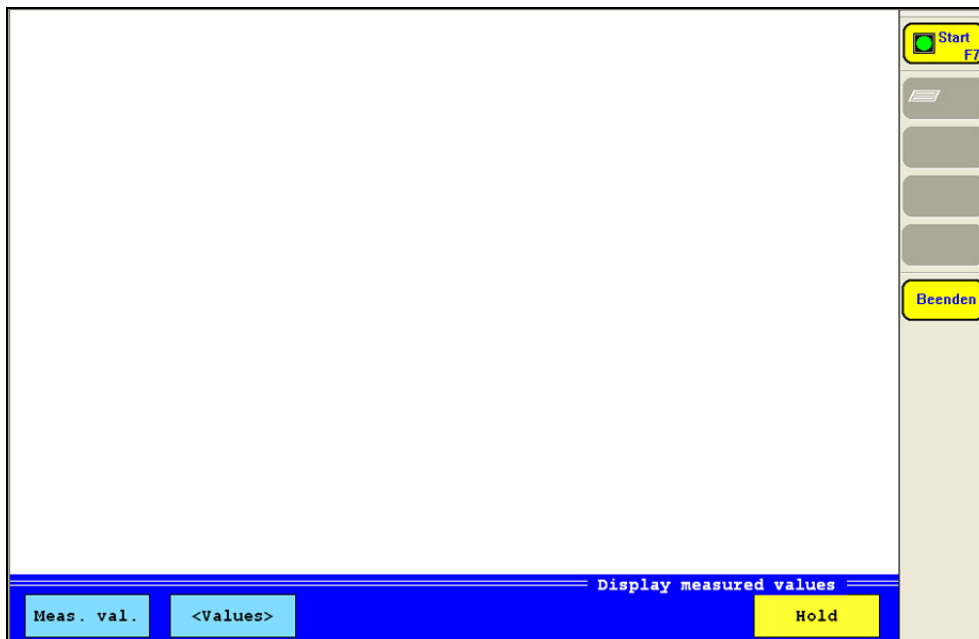

Pic. 54 Starting a test procedure

The name of the current test procedure is displayed in the lower right corner. Now touch [Start] and follow the instructions on the screen. Touch [End] to end the test procedure and return to the standard measuring mode.

8 Operation

In this chapter we will explain all functions of the **HYDROlink** software. Wherever contents differ between the operation of the different measuring instruments, it will be indicated clearly.

8.1 Start the software

Double-click on the software icon or start it by opening the folder Start – Programs and clicking on the respective link. Then the offline screen will be displayed:

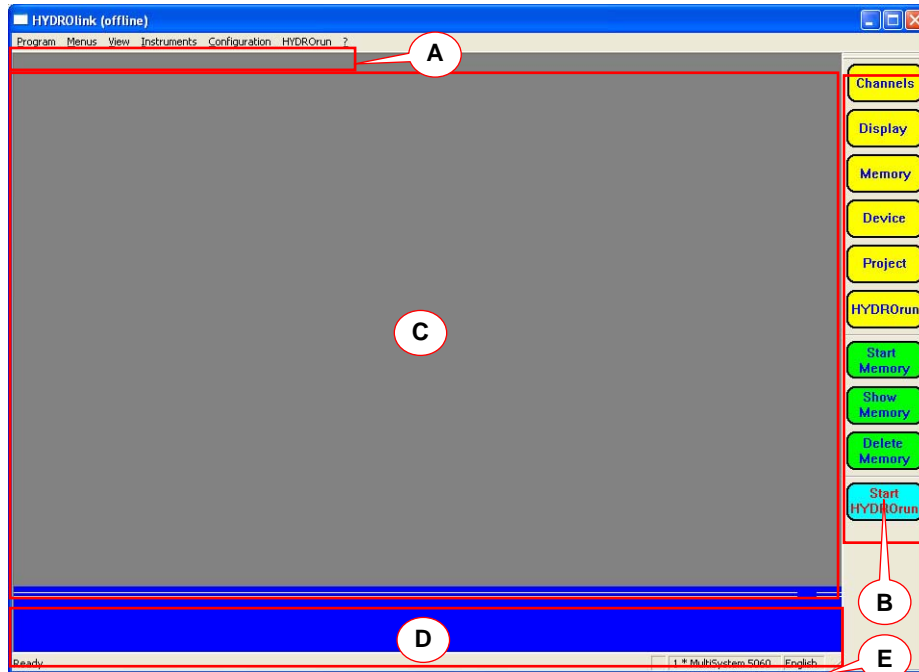

Pic. 1 **HYDROlink** offline screen

You can also start the software by double-clicking a **HYDROlink** configuration file (*.htc). Then the software will be launched with the desired configuration. In this case, data transfer from PC to instrument will be possible during instrument connection, only.

8.2 Functional parts of the screen

In Pic. 1, the functional parts are indicated by red lines and letters:

- A menu bar: contains the operation menus
- B tool bar: contains buttons providing quick access to important functions
- C display area: contains measurement display when software is connected to an instrument
- D function key bar: contains buttons with quick access to important functions; content depends on the current context
- E status bar: shows whether the software is ready for operation, the number and type of detected measuring instruments, and the current operation language

8.3 Connect with a measuring instrument



Attention

Possible loss of data!

When an instrument is connected with HYDROlink, you should not connect any USB devices to the PC. Otherwise the connection between HYDROlink and the instrument will be cut by the operating system of the PC.

Assure that the measuring instrument is connected to the PC and has been detected correctly. If the PC could not detect the instrument, the driver must be installed. Please refer to the product CD or your Hydrotechnik partner. Assure that the device to be connected displays the measured values (no menu opened).

1. Open the menu "Instruments".
2. Select the command "Start communication":

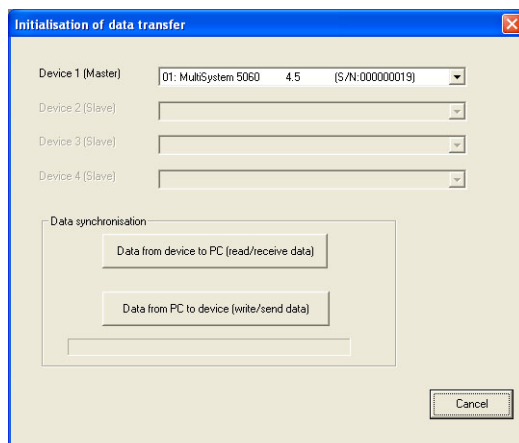

Pic. 2 Connected to a measuring instrument

The detected measuring instruments will be displayed. The software supports the remote control of max. two MultiSystem/Control/Panel 8050 (32 channels). All connected instruments will be controlled simultaneously.



Attention

Possible configuration problems!

After the installation of **HYDROlink** and the **first** connection of a measuring instrument, you should only use the option "Data from device to PC". This is the only way to store a valid configuration in the PC.

3. Either click on one of the "Synchronisation data" buttons to start the communication:

Data from device to PC transfers the settings and measuring data from the connected instrument to the PC
Data from PC to device transfers the settings and measuring data from the PC to the connected instrument

4. Wait until the synchronisation has been completed:

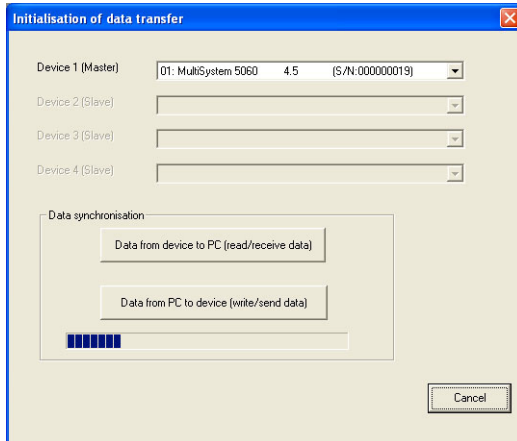

Pic. 3 Synchronisation in progress

5. Then the **HYDROlink** online screen will be displayed:

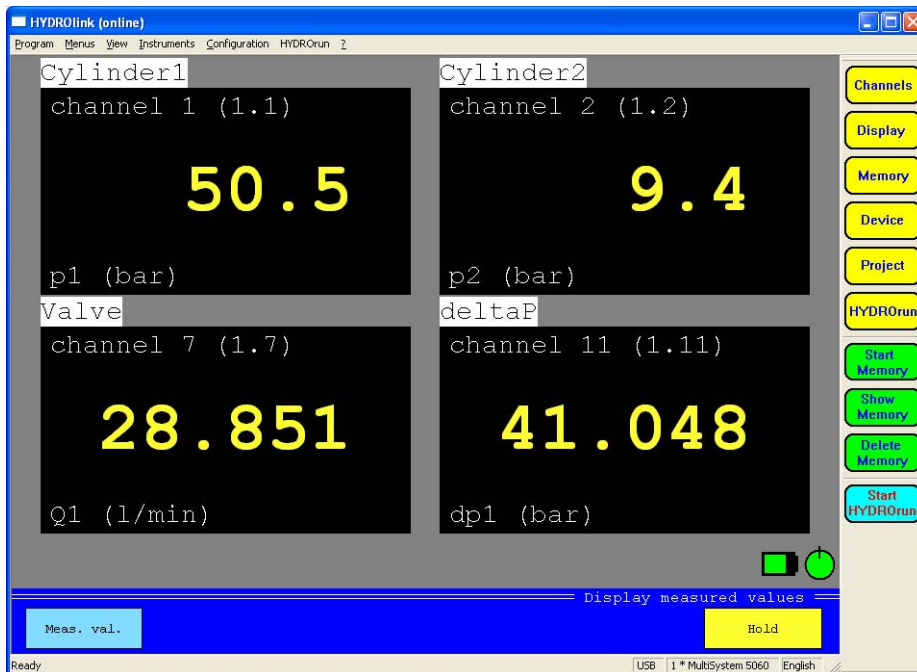

Pic. 4 **HYDROlink** online screen (text mode – measured values)

8.4 **HYDROlink** screen modes

The values measured by the connected instrument can be displayed in three different modes:

- | | |
|-----------------------------|--|
| Text mode (measured values) | the measured values are displayed (see Pic. 4 on page 57) |
| Text mode (MinMax values) | the measured values are displayed together with their minimal and maximal values (see Pic. 5 on page 58) |
| Graphic mode | the measured values are displayed as curves (see Pic. 6 on page 58) |

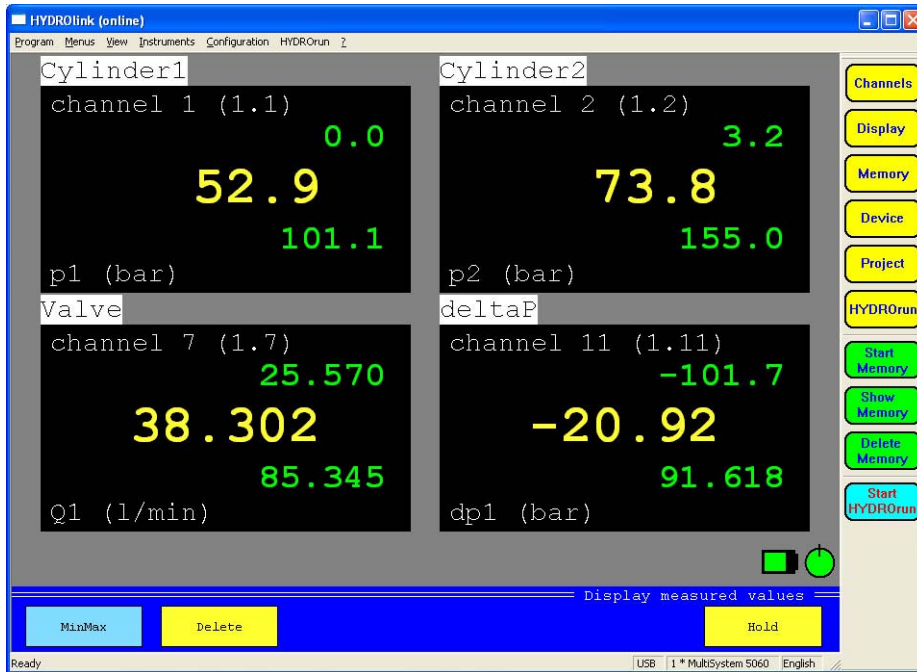

Pic. 5 HYDROlink online screen (text mode – MinMax values)

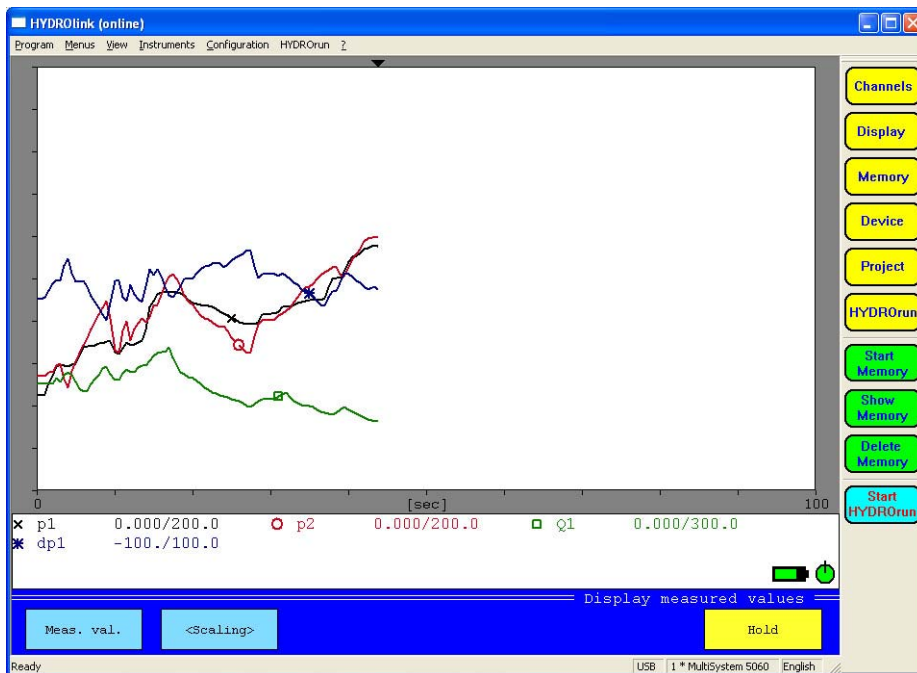

Pic. 6 HYDROlink online screen (graphic mode)

8.5 Operations during monitoring measured values

In all of the three online modes, you have a few operational possibilities:

- Hold “freezes” the display, the button color turns into green; click the button again to refresh the display with the current measured values
- MinMax/Meas.val. switches between the two display modes
- Scaling/Values in graphic mode, either the scaling range of each measurand, or of the current measured values can be displayed beneath the graph; click on this button to toggle between both display modes

8.6 HYDROlink operation menus

8.6.1 Program menu

The program menu contains the command “Exit”, only. Use this to shutdown the software.

8.6.2 Menus menu

This menu contains access to the operation menus of the connected instrument and some additional functions and commands. All the menus and commands are explained in the chapter for the operation of the connected measuring instrument.

8.6.3 View menu

Here you can control the look of the **HYDROlink** screen:

Tool bar displays/hides the tool bar containing the quick access buttons to the control menus of the connected instrument
Status bar displays/hides the status bar at the lower edge of the screen

8.6.4 Instruments menu

This menu contains two commands:

Start communication when a measuring instrument is connected to the PC, the communication between **HYDROlink** and the instrument must be started with this command
Disconnect use this command to end the communication between **HYDROlink** and the connected measuring instrument
Demo mode starts the software with virtual measuring instruments; you can use this function to check the complete functionality of **HYDROlink**

8.6.5 Configuration menu

Here you can do some settings for the **HYDROlink** software:

Language select the operation language
Options opens a dialog with some basic settings (see below)
Load loads a **HYDROlink** configuration file
Save saves the current **HYDROlink** configuration in a file

System options

This dialog is only available, if there is no communication with a connected measuring instrument. Possibly you will have to use the command “Instruments – Disconnect”. Then you may select the command “Configuration – Options” to display this dialog:

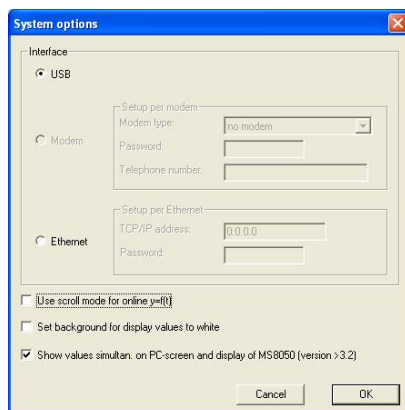

Pic. 7 System options

Select the interface used for the remote control of the measuring instrument(s). If “Modem” is selected, you can choose the desired modem and enter password and telephone number. If “Ethernet” is selected, you may enter the network address and the required password.

Additionally you can set three options regarding the measured value display:

Use scroll mode	if graphic display is selected and the screen is "full" (graph lines reach the right edge of the display), the complete display is shifted in scroll mode; if this option is disabled, the new values will overwrite the old graph lines from left to right
Set background to white	if this option is selected, the measured values in text display will be shown with black digits on white background
Show values ...	shows the measured values on PC and measuring system simultaneously; the display refresh will be reduced to 500 ms automatically and max. three measured values are used to calculate the displayed value; the keyboard of the measuring system is locked during parallel display mode

Click on "OK" to save the options. When starting the communication with the instrument, you should select the command "Data from PC to device". Otherwise the configuration will be loaded from the instrument and the changes done here are lost.

8.6.6 ***HYDRO*run menu**

Contains two functions for operations regarding the optional **HYDRO**run functions:

Transfer test procedure	used to transfer a test procedure to the measuring instrument
Read data base	receives information on the test procedures stored in the instrument

The second function is available at any time. To use the other **HYDRO**run functionalities of **HYDRO**link require a license of the **HYDRO**gen / **HYDRO**run software package. Please see the **HYDRO**gen / **HYDRO**run operating instructions for further information.

9 Technical Data

Inputs, Outputs, Channels

Analog measuring channels	10, including 2 Highspeed
... Measuring rate	1 ms, Highspeed 0.1 ms
... Input signals	0(4) ... 20 mA, 0 ... 10 VDC, ± 10 VDC
... Resolution A/D-converter	16 Bit
... Error limit	± 0.1 % FS
Frequency measuring channels	4
... Input frequency	0.25 Hz ... 20 kHz (without direction detection) 0.25 Hz ... 5 kHz (with direction detection)
... Error limit	± 0.2 % of measured value
Measuring channel current	± 2 ADC
Measuring channel voltage	± 48 VDC
Sensor detection	Hydrotechnik ISDS on all analog and frequency measuring channels
Calculated channels	6 (optionally 14)
... pre-defined formulas	4
... free definable formulas	yes
CAN channels	6 (optionally 14)
Digital inputs	4, one galvanically isolated
Digital outputs	4
Analog outputs	2

Data recording

Trigger type	selectable
... Quantity	2
Data memory	SD-card 256 MB, expandable to 1 GB

Features

Interfaces	USB, RS232, LPT, LVDS
Power supply	24 VDC
Fusing	self-reversing fuse resistors
Protection against ...	wrong polarity, over-voltage
Sensor power supply	12 VDC

Qualities and Limits

Operating temperature range MS 8050	0 ... 40 °C at humidity < 85%, not condensing
Operating temperature range MC 8050	0 ... 60 °C at humidity < 85%, not condensing
Storage temperature range	-20 ... +60 °C
Protection type	IP 40
CE labelling	EN 50081-1 and EN 50082-1
Conformity	RoHs
Casing	Aluminium, powder-coated, RAL 3004
Dimensions (L x W x H)	~ 310 x 254 x 60 mm
Weight	~ 3,100 g